

# CLIFFORD

PERFORMANCE PRODUCTS

## 4 and 6 cylinder specialists

CELEBRATING



1969 - 1999

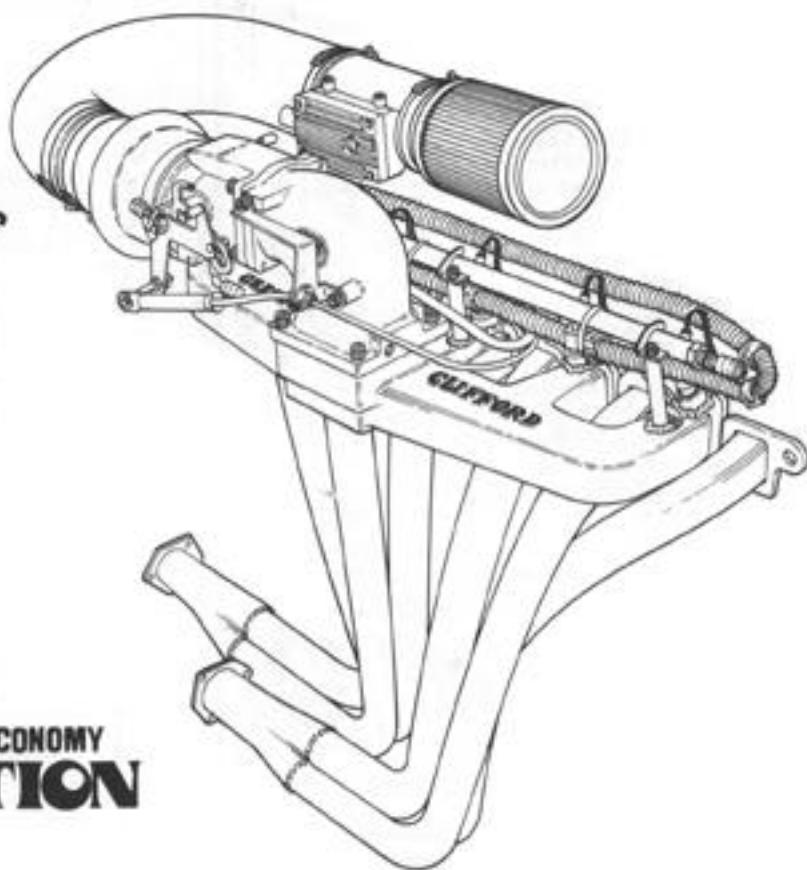

The PERFORMANCE & ECONOMY  
**COMBINATION**

6-8

Catalog No. 25

# contents

AIR CLEANERS & ELEMENTS.....	21
CAGLE FUEL REGULATORS.....	20
CAMS & KITS - DOMESTIC.....	24 thru 32
CAMS & KITS - FOREIGN.....	33/34
CARB. ADAPTERS & BASEPLATES.....	17
CARBURETORS - DOMESTIC.....	21
CARBURETOR HEAT-PLATE KITS.....	14
CARBURETORS - WEBER.....	18
CARB. LINKAGE.....	21
CARB. SYNCHRONIZER GUAGES.....	21
CLUTCH COMPONENT PARTS.....	
Bellhousings, Safety Type.....	41
Clutch Discs.....	42
Flywheels.....	41
Pressure Plate Assys.....	42
CONSUMER ACCESSORIES.....	43
EXHAUST SYSTEMS:DATSUN-Z.....	10
FUEL INJECTION.....	22
GASKETS, ENGINE REBUILDING & HEAD.....	37
HEADER SYSTEMS.....	
AMC, Passenger Cars.....	9
Ford Passenger Cars.....	8
GM Passenger Cars.....	7
Mini Trucks, Toyota L.C. & Land Rover.....	6
Mopar Passenger Cars.....	9
Race Car.....	11
Street Rod.....	11
Truck & Jeep.....	5
Van.....	4
FOREIGN CAR HEADERS.....	10
HARMONIC DAMPERS.....	38
HEADER COMPONENTS.....	
Collectors.....	13
Exh. Port Divider.....	8
Flanges & Flange Kits.....	13
Header Gaskets.....	12
Mufflers.....	12
Street Hookup (Reducer) Kits.....	13
U-Bends.....	12
HEAD STUD KITS.....	37
IGNITION COMPONENTS.....	
Jacobs Computer Ignition.....	38
Mallory Distributors & Ignition Parts.....	39
INTAKE MANIFOLDS.....	
2 & 4 Brl. Manifolds.....	15/22
2 Carb Manifolds.....	16
3 Carb Manifolds.....	16
Weber Manifolds & Carbs.....	18
PISTONS - CAST & FORGED.....	40
PISTON RINGS.....	40
RODS - Hi-Perf. Alum. & Steel.....	38
SUPER CHARGERS.....	43
TIMING GEAR SETS.....	35
THROTTLE & PEDAL KITS.....	21
TIMING COVER (2 Piece Chevy).....	35
VALVE COVERS & SIDE PLATES.....	23
VALVE TRAIN COMPONENTS.....	34/35/36
WEBER CARB. PARTS & ACCESS.....	19
WEBER CARB. CONVERSION KITS.....	20



# application codes

1. FITS with Automatic Transmission only.
2. FITS with Manual Transmission only.
3. Does NOT fit with Power Steering.
4. Does NOT fit with Power Brakes.
5. Does NOT fit with Air Conditioning.
6. Does NOT fit Integral intake manifold type cylinder head.
7. FITS with Passenger side starter location only.
8. FITS with Driver's side starter location only.
9. Does NOT fit Saginaw power steering pump driver's side location.
10. Does NOT fit with Fuel Injection.
11. FITS with starter located at oil pan level only.
12. FITS with starter located under the intake manifold only.
13. REQUIRES modification to engine compartment and spring mount.
14. REQUIRES 240-Z smog nozzles and harness be used.
15. FITS 1963 models with slant back firewall. If equipped with early firewall, use No. 52-0112
16. FITS with alternators only.
17. FITS with 5 o'clock lever arm bellhousing (stock Chevy II) only.
18. FITS with 3 o'clock lever arm bellhousing (V-8 type) only.
19. FITS with Integral intake manifold cylinder head (2 brl. carb design) only.
20. REQUIRES use of 1951 or 1955 thru 1957 front motor mounts. (use "Street Rod" headers when using stock mts.)
21. FITS with Saginaw power steering only.
22. REQUIRES fender well splash pan be trimmed for "Fender well" type rear header section design.
23. FITS with engine set back and low ground clearance (inside frame designed header).
24. CHECK for availability on Smog model type design.
25. REQUIRES use of 14 inch rims for proper ground clearance.
26. FITS with "Select 4 wheel Drive" only. (Transfer case on driver's side)
27. FITS with Integral intake manifold cylinder head (1 brl. carb. and 6 exhaust port design head only)
28. Does NOT fit NAP-Z engine. 1981 and later.
29. FITS OEM stock E.F.I systems and has all smog fittings.
30. AMC spacer kit required when using stock intake manifold prior to 1981. Order PN 77-1000 spacer kit. (spacer makes up the difference between a 3/8" thick flange to a 1-3/8" thick)
31. AMC 232 & 258 engines can use late 242 (4.0 liter) E.F.I. cyl. heads. See new intake manifolds page 15.



Most 6 cylinder headers in this catalog are "Dual Outlet" type, and all 4 cylinder headers are "Single Outlet" unless otherwise noted. 16 gauge steel tubing is used for most applications.

The products listed in this catalog are intended for racing purposes only and should be installed in accordance with state regulations pertaining to emission standards. It is also recommended that all smog control and catalytic converters be retained as required by law. California Vehicle Code Section 27156 prohibits the advertising, offering for sale, or installation of any device which modifies a vehicle's emission control system. Clifford headers have not yet received an exemption from this code section, and are, therefore, not legal for sale or use in California on vehicles equipped with catalytic converters.

# The PERFORMANCE & ECONOMY COMBINATION

6=8

For many years people have misunderstood and questioned the **6=8** logo used by CLIFFORD PERFORMANCE. What does it MEAN? What does it STAND FOR? HOW can **6=8**? WHEN does **6=8**? Well, the fact is that **6** CAN equal **8** when applied in terms of ENGINE PERFORMANCE.

CLIFFORD PERFORMANCE was founded by Jack Clifford in 1967 as a manufacturer of performance products primarily designed to increase the performance and driveability of the Detroit-produced 6 cylinder engine. Being an Aerospace engineer by profession, Jack realized the lack of power produced by these engines, but understood the capability and practicality of the Inline Engine Design.

Several years of research and testing proved that a small displacement Inline 6 cylinder, properly modified, would produce equal and, in some cases, more usable low R.P.M. power than a large displacement V-8 engine — thus the Trademark **6=8**

Properly designed product, used in COMBINATION with each other, is the key to any engine's overall performance. Intake Manifold design, Exhaust Manifold or Header design, Camshaft design, Connecting Rod Ratio, Carburetor size and design, etc., etc., are all important factors in determining how well your vehicle performs and how much fuel it consumes. The new car builders realize this and do an excellent job of design. Engineers in Detroit must also design parts which will be easily mass-produced at a minimum cost. This is, in most cases, accomplished at the expense of performance.

Jack Clifford began by designing and testing exhaust headers. During his tests, it became very clear that a set of headers improved the overall performance of an Inline 6 engine tremendously. It also became clear that, with the improved exhaust system, a modification to the intake system would, again, make a large performance gain. A complete line of intake manifolds were designed. Each manifold was designed to be compatible, and to be used in conjunction with a set of Clifford Performance headers. To explain further — the runner length, plenum size and flow characteristics of each Clifford intake manifold matches the primary pipe diameter of the exhaust header, the displacement of the cylinder, the connecting rod ratio, etc. The end result of this extensive research and development program is a complete line of 6 cylinder exhaust headers, cams and a complete line of 6 cylinder intake manifolds which are matched in such a manner as to be used in COMBINATION with each other. Thus "THE COMBINATION".

From the very beginning, Jack Clifford has demanded quality in the manufacture of his company's product. Each and every header is constructed of 16 gauge tubing and is heli-arc welded. Each header is equipped with a collector designed to allow easy removal of the exhaust system. Clifford Performance's overall policy is the "Build the Best", not the cheapest, and to maintain that quality throughout the entire product line.

## BASIC STAGES OF TUNING FOR BALANCED POWER

<p><b>STAGE I</b> 2000 to 4500 RPM Range</p>	<p>STOCK STREET ENGINE with 25% more rear wheel H.P. over stock by adding the following equipment:</p> <p>(a) Headers with single exhaust system (b) 2 or 4 barrel intake manifold</p>
<p><b>STAGE II</b> 2000 to 5000 RPM Range</p>	<p>SUPER STREET and OFF-ROAD ENGINE with 40% more rear wheel H.P. over stock by adding the following equipment:</p> <p>(a) All of Stage I (b) Higher performance camshaft of 260° to 270° duration (c) Recurved stock ignition or aftermarket HI-Perf. distributor and coil (d) Mill head .060" or higher compression pistons (9 or 10 to 1 C.R.)</p>
<p><b>STAGE III</b> 3000 to 7000 RPM Range</p>	<p>FULLY BLUEPRINTED ENGINE for DRAG or OVAL TRACK RACING (Not recommended for Street!) approximately 100% or more H.P. to rear wheels depending on equipment used below:</p> <p>(a) Dual outlet headers (b) Full competition head work (c) High compression forged pistons (11 or 12 to 1 C.R.) (d) Multi-carburetion, dual Quads or Webers (e) Maximum bore and stroke as per class rules</p>

This Catalog has other information on how to select the proper Exhaust System for our Headers listed on Page 4, and how to select the proper Cam listed on Page 24.

Again we emphasize — The ideal modification per dollar spent is "THE COMBINATION" of a CLIFFORD EXHAUST HEADER, CLIFFORD CAM and a matching CLIFFORD INTAKE MANIFOLD.

YOU WILL AGREE — **6=8**

**DODGE - MOPAR APPLICATION CODES**

1. FITS with Automatic Transmission only.
2. FITS with Manual Transmission only.
3. Does NOT fit with Power Steering.
5. Does NOT fit with Air Conditioning.
11. FITS only with starter located at oil pan level.
12. FITS only with starter located under the intake manifold.
13. FITS only after modification to engine compartment and spring mount.

BODY STYLE      YEAR      ENGINE SIZE      CODES (See page 2)      PART No.

## CHEVROLET & GMC VANS

1/2 & 3/4 TON	1963-75	230,250,292	6	52-0960
	1976-87	292	—	52-0768
	1975-78	250 w/new head design	27	52-1920
	1975-87	250 w/pre '75 head design	6	52-0768
	1963-87	230,250,292 (automatic only)	1,6	(new) 52-0014

## FORD ECONOLINE VANS

1/2 & 3/4 TON	1960-67	144,170,200,250 (sgl. outlet)	5	53-2600
	1960-67	144,170,200,250	5	53-0496
	1968 up	240,300	—	53-0688
	1965 up	240,300 (sgl. outlet)	—	(new) 53-2750
	1987 up	300 (sgl. outlet)	29	(new) 53-2760

*wiegr & of smog*

## DODGE VANS

1/2 & 3/4 TON	1964-69	198,225	High	1,5,12	55-0656
	1964-69	198,225	High	2,5,12	55-0272
	1970 up	198,225	High	5,12	55-0464
	1968 up	198,225	Low	5,11,13	55-0400
	1964 up	198,225	High (sgl. outlet)	—	55-2600
	1964 up	198,225	Low (sgl. outlet)	—	(new) 55-2650

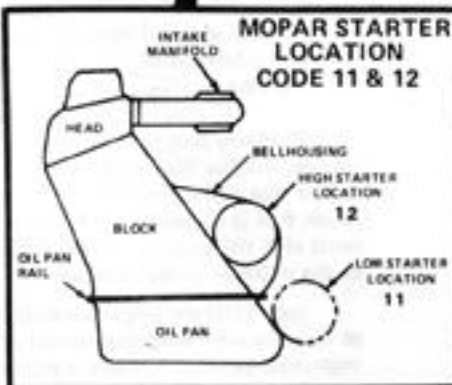

USE FOLLOWING CHART TO SELECT THE PROPER EXHAUST SYSTEM FOR YOUR HEADERS \*

ENGINE SIZE & DESCRIPTION	STAGE OF TUNING			TYPE OF HEADER		HEAD PIPE O.D.						TYPE OF MUFFLER		TAIL PIPE O.D.						
	I	II	III	Single Outlet	Dual Outlet	1-1/2"	1-5/8"	1-3/4"	1-7/8"	2"	2-1/4"	2-1/2"	Stock	Turbo	1-1/2"	1-5/8"	1-3/4"	2"	2-1/4"	
4 CYLINDER 1200cc to 1800cc	Yes	—	—	Yes	—	Yes	—	—	—	—	—	—	Yes	Opt	Yes	—	—	—	—	—
	—	Yes	—	Yes	—	—	—	Yes	—	—	—	—	Opt	Yes	—	—	Yes	—	—	—
	—	—	Yes	Yes	—	—	—	—	—	Yes	—	—	—	Yes	—	—	—	Yes	—	—
4 CYLINDER 1900cc to 2400cc	Yes	—	—	Yes	—	—	—	Yes	—	—	—	—	Yes	Opt	—	—	Yes	—	—	—
	—	Yes	—	Yes	—	—	—	—	Yes	—	—	—	—	Yes	—	—	Yes	—	—	—
6 CYLINDER 140 cid to 250 cid	—	—	Yes	Yes	—	—	—	—	—	Yes	—	—	—	Yes	—	—	—	—	—	—
	—	Yes	—	Yes	—	—	—	—	—	Yes	—	—	—	Yes	—	—	—	Yes	—	—
6 CYLINDER 260 cid to 300+ cid	Yes	—	—	—	Yes	Yes	—	—	—	—	—	—	Yes	No	—	—	—	—	—	—
	—	Yes	—	—	Yes	—	—	Yes	—	—	—	—	—	Yes	No	—	—	—	—	—
6 CYLINDER 140 cid to 250 cid	—	—	Yes	—	Yes	—	—	—	—	Yes	—	—	—	Yes	—	Yes	—	—	—	—
	—	—	—	—	Yes	—	—	—	—	—	—	—	—	Yes	—	—	—	Yes	—	—
6 CYLINDER 260 cid to 300+ cid	Yes	—	—	—	Yes	—	—	Yes	—	—	—	—	Yes	No	—	—	Yes	—	—	—
	—	Yes	—	—	Yes	—	—	—	—	Yes	—	—	—	Yes	No	—	—	Yes	—	—
6 CYLINDER 140 cid to 250 cid	—	—	Yes	—	Yes	—	—	—	—	—	—	Yes	—	Yes	—	—	—	—	—	Yes
	—	—	—	—	Yes	—	—	—	—	—	—	—	—	Yes	—	—	—	—	—	Yes

NOTE: All dual outlet 6 cyl. headers can be made into single outlet type by making a "Y" pipe hook-up like V-5's & V-8's.

DO NOT use Turbo mufflers on dual exhaust systems unless you have full competition engine !!

\* NOTE: When using M.P.I. fuel systems use 2 sizes larger pipe.

SEE PAGE (11) for "STREET ROD" headers

BODY STYLE	YEAR	ENGINE SIZE	CODES (See page 2)	PART No.
<b>CHEVROLET &amp; GMC TRUCKS</b>				
1/2, 3/4 TON TRUCKS, BLAZERS & JIMMYS	1948-59	216,235,261	2,3,4,5	52-0832
	1960-62	235,261	2,3,4,5	52-1024
	1948-59	248,270,302	3,4,5	52-2496
	1960-62	248,270,302	2,3,4,5	52-2560
	1963-87	2 & 4 w/d 230,250 w/pre '75 head	6	52-0768
	1963-87	2 & 4 w/d 292	—	52-0768
	1963-87	2 & 4 w/d 230,250,292 (automatic only)	1,6	(new) 52-0014
1979-87	2 & 4 w/d 250 w/pre '75 head design	6	52-0768	
<b>FORD TRUCKS</b>				
1/2 & 3/4 TON TRUCKS (also 1 ton)	1955-60	2 & 4 w/d 223,262	3,4,5	53-0752
	1961-64	2 w/d 223,262	3,4,5	53-1968
	1965-79	2 w/d 240,300	—	53-0816
	1965-79	4 w/d 240,300	—	53-0880
	1980 up	2 & 4 w/d 240,300	—	53-0960
	1965-79	2 w/d 240,300 (sgl. outlet)	—	53-2700
	1965-79	2 w/d 240,300 (sgl. outlet, smog)	29	53-2710
	1980 up	2 & 4 w/d 240,300 (sgl. outlet, smog)	29	(new) 53-2760
BRONCO	1966-77	4 w/d 170,200,250	5	53-0944
	1978-79	4 w/d 240,300	—	53-0880
	1980 up	2 & 4 w/d 240,300	—	53-0960
<b>MOPAR TRUCKS</b>				
1/2, 3/4 TON TRUCKS, RAMCHARGER & TRAIL DUSTER	1960-71	2 w/d Low Starter 198,225	5,11	55-0336
	1972-87	4 w/d Low Starter 198,225	5	55-0592
	1960-87	2 w/d Hi Starter 198,225	5,12	55-0528
	1972-87	2 w/d Low Starter 198,225	3,5,11	55-0720
	1960-87	2 & 4 w/d Hi/Str. 198,225 (sgl. outlet)	5,12	55-2600
	1960-87	2 & 4 w/d Lo/Str. 198,225 (sgl. outlet)	5,11	55-2650
See Mopar codes on page 4				
<b>INTERNATIONAL</b>				
SCOUT	1961-70	152 (4 cyl.)	5	57-0752
	1972-74	232,258	30	57-0560
	1977-79	196 O.H.V.	5	57-0784
<b>AMC - JEEP</b>				
CJ5, CJ6, CJ7, CJ8 COMMANDO & POSTAL JEEPS W/RH. STEERING	1972-86	232,258 dual outlet	2,30	57-0300
	1972-86	232,258 single outlet	30	57-0980
	1980-83	151 cu. in. 4 cyl. (GM engine)	—	57-0900
	1984 up	2 & 4 w/d 150 cu. in. 4 cyl. (AMC engine)	29 w/smog	57-1000
	1972-86	232,258 w/4.0 liter head (dual outlet)	31	57-1300
1972-86	232,258 w/4.0 liter head (single outlet)	31	57-1380	
EAGLE 4 w/d	1979-86	258 single outlet	1,26,30	57-0430
PICKUP (J-10)	1972-79	232,258	30	57-0420
	1980-85	258	26,30	57-0410
PICKUP (J-20)	1972-79	232,258	3,4,30	57-0400
CJ5 w/V6 ENGINE	1966-71	225 V6 (fenderwell exit)	2,3,4,5	57-0368
JEEP 4 cyl. ("F" HEAD)	1950-70	134	2,3,4,5	57-0432
JEEP 4 cyl. (CHEVY II)	1950-70	153	2,3,4,5,21	57-1856
WAGONEER/CHEROKEE WRANGLER/COMANCHE	1972-79	232,258	3,30	57-0400
	1980-86	258 (no smog)	26,30	57-0410
	1987-90	258 dual outlet (w/smog)	29	57-0415
	1987-90	258 single outlet (w/smog)	29	57-0988
	1987-90	258 single outlet (no smog)	—	57-0999
	1987 up	242 (4.0 liter E.F.I.) single outlet	29	57-2000
	1987 up	242 (4.0 liter E.F.I.) dual outlet	29	57-2015
	1984 up	150 cu. in. 4 cyl. (AMC engine)	29 w/smog	57-1000

These products are intended for racing purposes only. See back cover for other limitations.

SERMATIZE your headers with a life-time Metallic-Ceramic coating. See page 43 for details.

SEE PAGE (11) for "STREET ROD" headers

BODY STYLE      YEAR      ENGINE SIZE      CODES  
(See page 2)      PART No.

## DATSUN / NISSAN

DATSUN 521/620 PICKUP	2 & 4 w/d	1973-77	1800-2000cc (L18-L20) (sq. port) (w/smog)	50-1888
DATSUN 620/720 PICKUP	2 & 4 w/d	1978-80	2000cc (rd. port) (L20) 28 (w/smog)	50-2644
DATSUN 720 PICKUP	2 & 4 w/d	1981-85	2200, 2400cc (Nap-Z engine) (w/smog)	50-2675
PATHFINDER & HB'S	4 w/d	1986-88	3000cc, V-6 (w/smog)	50-2700

## TOYOTA MINI-TRUCK

TOYOTA PICKUP	4 w/d	1978-84	2000-2200-2400cc (no smog)	2	50-2784
TOYOTA PICKUP	2 & 4 w/d	1975-83	2000-2200-2400cc (w/smog)	2	50-2800
TOYOTA PICKUP	4w/d	1988-89	3000cc V-6 (w/smog)	—	50-2825

## TOYOTA LANDCRUISER

		1968-87	236.7,258 single outlet	2,3,4,5	50-2336
		1968-87	236.7,258 dual outlet	2,3,4,5	50-2848
STATION WAGON ONLY		1980-85	236.7,258 single outlet	2,3,4,5	50-2340

## BRITISH LANDROVER

*Header requires modification if power winch is used \**

* LANDROVER 4 cyl.		1956-74	2½ litre	2,4,5	50-0416
--------------------	--	---------	----------	-------	---------

## CHEVROLET, GMC & ISUZU

LUV except cross flow head		1972-75	1800cc (2 & 4 w/d)	—	52-1344
LUV, ISUZU 2 & 4 w/d		1976-85	1800cc	—	52-1352
ISUZU 2 & 4 w/d		1981-92	1800-2000cc	—	52-1352
CHEVY S-10/GMC S-15	1982-90		151 cu.in. (crossflow) 2&4 w/d (w/smog)		52-1362
BLAZER & JIMMY			2800cc V-6 2 w/d (smog) (new)		52-1375

## FORD COURIER, MAZDA, RANGER

COURIER, MAZDA	}	{	1972-78	1800-2000cc (round port) (w/smog)	53-2082
2 w/d			1979-83	2300cc (round port) (w/smog)	53-2040
MAZDA-B2000	}	{	1978-84	2000cc (sq. port) (Passenger Side Exit)	(new) 53-2140
RANGER, BRONCO II			}	{	1983-85
2 & 4 w/d	1986-89	2900cc V-6 (2.9 liter) 2 & 4 w/d			53-2100
	1982-90	2300cc 4 cyl. 2 w/d			53-2160

## MOPAR

DODGE D50, MONTERO	}	{	1979-89	2000, 2600cc (Mitsubishi) (even port)	55-1050
PLYMOUTH ARROW					
DAKOTA 4W/D	}	{	1987-90	3.9 liter V-6 (w/smog)	55-1070
MONTERO RAM -50					
2 & 4 w/d			1982-89	2000-2600cc 4cyl. (paired port) (w/smog)	55-1080

## SUZUKI

SAMURI 4W/D		1983-89	1.3 liter (w/smog)	—	50-3000
-------------	--	---------	--------------------	---	---------

## ISUZU

TROOPER II 4 W/D		1984-87	2.3 liter (w/smog)	—	50-3100
------------------	--	---------	--------------------	---	---------



BODY STYLE	YEAR	ENGINE SIZE	CODES (See page 2)	PART No.
<b>CHEVROLET 6 cyl. passenger cars *</b>				
BEL AIR & 210 SERIES	Pre-1955	216,235,261	2,3,5,20	52-0640
	1955-57	235,261	2,3,5	52-0000
BEL AIR IMPALA BISCAYNE	1958-62	235,261 dual outlet	2,3,5	52-0064
	1958-64	194 thru 292	2,5	52-0896
	1965-74	194 thru 292	2,5	52-1088
CHEVY II & NOVA	1962-67	194 thru 250 (single outlet)	1,5,16	(new) 52-2600
	1962-67	194 thru 250	2,5,16,25	52-0128
	1962-67	292	2,17	52-0192
	1962-67	292	2,5,18	52-0320
	1968-74	194 thru 250	5	52-1962
	1968-72	292	2,5	52-0448
	1975-77	250 w/new head design	27	52-1984
CAMARO	1975-up	250 W/pre-'75 head	—	52-1962
	1967-74	194 thru 250	5	(new) 52-2600
	1967-69	292	2,5	52-1962
	1975-78	250 w/new head design	27	52-0448
	1975 up	250 W/pre-'75 head	—	52-1984
CHEVELLE EL CAMINO MALIBU	1975 up	250 W/pre-'75 head	1	(new) 52-2600
	1964-74	194 thru 250	5	52-1962
	1964-77	292	2,5	52-0576
	1978-85	231 V-6	1	52-2752
MALIBU, EL CAMINO MONTE CARLO	1975 up	250 W/pre-'75 head	—	52-1962
	1980-85	231 V-6	—	(new) 52-2600
MONZA	1975-78	231 V-6	—	52-2252
<b>CHEVROLET 4 cyl. passenger cars</b>				
VEGA	1971-77	2300cc single outlet	5	52-1280
	1978-84	151 crossflow (4 cyl.)	—	52-1370
CHEVY II & NOVA	1962-67	153	2,5,16	52-1408
	1968-70	153	2,5	52-1792
<b>BUICK passenger cars</b>				
SPECIAL, SKYLARK & APOLLO	1964-74	230,250	1	(new) 52-2600
			5	52-1962
SKY HAWK	1975-78	231 V-6	—	52-2048
	1976-80	151 crossflow (4 cyl.)	3	52-1370
LA SABRE, REGAL	1977-84	231 V-6	—	52-2752
<b>OLDSMOBILE passenger cars</b>				
CUTLESS, OMEGA	1964-74	230,250	1	(new) 52-2600
			5	52-1962
STARFIRE	1975-78	231 V-6	—	52-2048
	1976-80	151 crossflow (4 cyl.)	3	52-1370
<b>PONTIAC passenger cars</b>				
TEMPEST, SPRINT & FIREBIRD	1964-65	215,250 O.H.V.	1	(new) 52-2600
			5	52-1962
FIREBIRD & TEMPEST	1966-70	230,250 O.H.C.	5	56-1962
VENTURA II	1971-72	292 O.H.V.	2,5	52-0448
	1971-74	250 O.H.V.	5	52-1962
			1	(new) 52-2600



*These products are intended for racing purposes only. See back cover for other limitations.*

SEE PAGE (1) for "STREET ROD" headers

BODY STYLE YEAR ENGINE SIZE CODES (See page 2) PART No.

### FORD/MERCURY INLINE 6 cyl. pass. cars\*

MAINLINE, CUSTOM, FAIRLANE, EDSEL, RANCHERO, MERCURY	1955-64	215,223,262	3,5	53-0048
	1952-54	215,223	3,5 (new)	53-0030
CUSTOM, GALAXIE	1965-77	240,300	5	53-1008
	1965-77	240,300 (single outlet)		53-2700
FALCON, COMET, RANCHERO, FAIRLANE, MUSTANG, TORINO, MAVERICK	1960-63	144,170,200	5,15,22	53-0112
	1964-77	170,200	5	53-0186
	1964-77	250	5	53-0368
	1963 1/2-77	144,170,200,250 (sgl.outlet)		53-2600
GRANADA, MONARCH, FAIRMONT, FUTURA, MUSTANG II, CAPRI II	1975 up	200,250 (sgl. outlet)		53-2600
		250 (dual outlet)		53-0368



### FORD/MERCURY V-6 passenger cars

PINTO & MUSTANG II	1974-78	2800cc	24	53-2224
MERCURY CAPRI	1972-73	2600cc	—	53-1520
	1974-75	2800cc	24	53-2288
CAPRI II	1977-78	2800cc	24	53-2288



### FORD/MERCURY 4 cyl. passenger cars

PINTO & BOBCAT	1971 & later	1600cc	—	53-1328
		2000cc	—	53-1264
FAIRMONT, FUTURA PINTO, MUSTANG II	1974-78	2300cc	24	53-2160
	1979-82	2300cc	—	53-2996
MERCURY CAPRI, CAPRI II	1971 & later	1600cc	—	53-1392
	1971-75	2000cc	—	53-1456
	1979-82	2300cc	—	53-2996



## EXHAUST PORT DIVIDER

### FORD 144-170-200-250 cu. in. engines

All Ford Falcon engines should be equipped with this exclusive cast iron port divider. It is designed to correct the flow of No. 3 and 4 exhaust port to equal that of the other cylinders. By doing so, each cylinder produces an equal amount of power at all RPM points, thus an increase of as much as 10% can be gained. This part is included with each 144-250 Ford header manufactured by Clifford Performance.

**NOTE:** This part should be bonded into place with Hi-Temp Epoxy or tack welded into port to prevent divider from coming loose later.

PART No. 73-1136

BEFORE

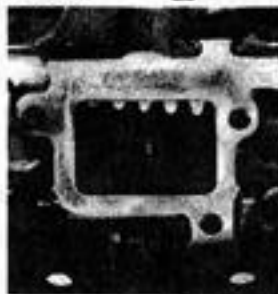

AFTER

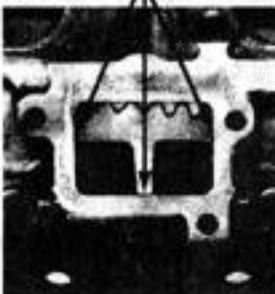

SEE PAGE (1) for  
"STREET ROD" headers



BODY STYLE	YEAR	ENGINE SIZE	COCKS (See Page 7)	PART No.
------------	------	-------------	-----------------------	----------

**DODGE • PLYMOUTH****6 cyl. passenger cars**

DART, VALIANT, BARRACUDA }	1960-66	225	25	55-0016
	1960-66	225	1	55-0100
	1960-66	225 (single outlet)	—	55-2600

ASPEN, BARRACUDA, CHALLENGER, DART, DEMON, DIPLOMAT, DUSTER, MIRADA, VALIANT, VOLARE }	1967-81	198,225	—	55-0144
	1967-81	198,225 (single outlet)	—	55-2600

INTERMEDIATE BODIES (All B & E Bodies)	1960-81	198,225	—	55-0144
ALL BODIES	1960 & later	198,225	—	55-2600

**4 cyl. passenger cars**

COLT, CHAMP }	1971-75	1400,1600cc ser. port only	—	55-0848
	1975-84	2000cc	—	55-0912

ARROW, CHALLENGER, SAPPORO }	1979-86	2000,2600cc (Mitsubishi)	—	55-1050
---------------------------------	---------	--------------------------	---	---------

**AMC 6 cyl. passenger cars**

AMERICAN, JAVELIN, HORNET, GREMLIN }	1965-72	199,232,258	8,30	57-0048
	1972-81	199,232,258	7 & 30	57-0176

PACER }	1974-78	232,258	24,30	57-0624
	1974-78	232,258 single outlet	30	57-0625

EAGLE (4w/d)	1979-86	232,258 single outlet	26,30	57-0430
--------------	---------	-----------------------	-------	---------

SPIRIT, CONCORD	1979-86	258	30	57-0450
-----------------	---------	-----	----	---------



BODY STYLE	YEAR	ENGINE SIZE	CODES (See page 2)	PART No.
------------	------	-------------	-----------------------	----------



## DATSUN/NISSAN passenger cars

510 SEDAN & WAGON	1968-74	1600 w/smog		50-1824
240, 260, 280-Z	1970-76	2.4, 2.6, 2.8, liter (dual outlet w/smog)		50-1440
240, 260, 280-Z	1970-76	2.4, 2.6, 2.8, liter (dual outlet NO smog)		50-1376
280 & 280-ZX	1977-79	2.8 liter (rd. port EFI dual outlet)		50-1472
240-Z	1970-72	2.4 liter (single outlet No smog)		50-1240
240-Z	1970-72	2.4 liter (single outlet w/smog)		50-1241
260-Z	1973-74	2.6 liter (single outlet No smog)		50-1260
260-Z	1973-74	2.6 liter (single outlet w/smog)		50-1261
280-Z	1975-78	2.8 liter (single outlet No smog)		50-1282
280-Z	1975-78	2.8 liter (single outlet EGR only)		50-1283
280-ZX	1979-82	2.8 liter (single outlet w/oxy only)		50-1280
280-ZX	1979-82	2.8 liter (single outlet w/oxy & EGR)		50-1281
300-ZX	1983-85	3.0 liter V-6, 18mm w/oxy only		50-1300
300-ZX	1986-90	3.0 liter V-6, 24mm w/oxy only		50-1310



## DATSUN EXHAUST SYSTEMS (HEADER TYPE)

These Exhaust Systems are designed to be used in conjunction with a set of Clifford Headers. THE COMBINATION of both will allow your engine to produce substantial increases in usable power and at the same time, retain good fuel economy.

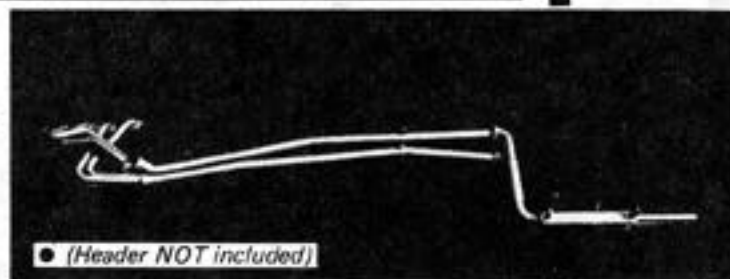

PART No.	YEAR	ENGINE SIZE		
50-1184	1970-79	240,260,280-Z (dual exhaust system w/dual glass pack muffler.)		
50-1248		DUAL GLASS PACK MUFFLER ONLY (Replacement for 50-1184 sys.)		
50-1504	1970-79	240,260,280-Z (dual exhaust system w/single turbo muffler.)		
50-1600	1970-79	260,280-Z 2+2 models (dual system using customer-supplied stock muffler.)		
50-1610	1970 up	240,260,280-Z (2-1/2" dia. sgl. outlet system w/turbo muffler. Fits all sgl. out. headers.)		
50-1620	1983 up	3.0 liter V-6 (2-1/4" dia. sgl. outlet system w/turbo muffler.)		

## TOYOTA passenger cars

TOYOTA CELICA	1971-74	1900cc O.H.C.	—	50-1952
	1974½-79	2200cc O.H.C.	—	50-2784
	1979-84	2200, 2400cc O.H.C. (20R/22R) w/smog	—	50-2785
TOYOTA COROLLA	1971-79	1600cc O.H.V. stick shift only	—	50-2016



## VOLVO passenger cars

ALL MODELS				
Carbureted intake manifolds	} 1962-75	1800, 2000cc	—	50-2912
	} 1970-75	2000cc	—	50-2925



BODY STYLE	YEAR	ENGINE SIZE	PRI. PIPE DIA. & LENGTH	CODES (See page 2)	PART No.
<b>CHEVROLET &amp; GM race cars</b>					
GM 4 cyl. 181cid	1968-72	181	1-5/8" x 30"		(new) 52-1800
<i>Marine engine in Chevy II/Nova</i>					
GM 4 cyl. crossflow head	1979 up	151	1-5/8" x 30"	—	52-1395
BEL AIR, IMPALA	1955-57	194,230,250	1-5/8" x 34"	**	52-1152
& BISCAYNE		292	1-5/8" x 34"	**	52-1216
CHEVY II & NOVA	1968-72	292	1-3/4" x 36"	2**	52-0448
CAMARO	1967-70	292	1-3/4" x 36"	2**	52-0448
CHEVELLE	1964-77	292	1-3/4" x 36"	2**	52-0576
DRAGSTER (front & rear engine)	—	230,250,292	1-7/8" x 32"	—	52-1472
<b>FORD race cars</b>					
FAIRLANE & MERCURY	1957-64	240,300	1-3/4" x 34"	23	53-1140
	1957-64	240,300	1-5/8" x 34"	22**	53-0240
COMET, FALCON	1960-63	240,300	1-3/4" x 34"	22**	53-0240
FALCON, MUSTANG, FAIRLANE	1964-67	240,300	1-3/4" x 34"	—	53-0304
MUSTANG, MAVERICK, COMET	1968-77	240,300	1-3/4" x 34"	—	53-0560
DRAGSTER (front & rear engine)	—	240,300	1-7/8" x 32"	—	53-2544

• NOTE: \*\* Modification required if used with a Weber carburetor assembly. Special order upon request. \$50.00

## STREET ROD HEADERS

CLIFFORD STREET ROD headers are designed to fit most body/engine combinations and ALL Clifford intake manifolds plus stock manifolds. These Universal Street Competition headers are designed to use a full length exhaust system for maximum tuning. They will work great where motor mounts, linkage and steering gear boxes are in the way of regular headers. Collectors exit approximately at the oil pan rail.

These headers are made from heavy 16 gauge steel tubing and feature our regular 2-1/2" dia. collectors. All headers come complete with gaskets and street reducers and NO smog fittings.

ENGINE MAKE	ENGINE SIZE	NOTES	PART NO.
PONTIAC OHC	230, 250	—	56-0010
GMC	228, 248, 270, 302	—	52-0040
CHEVROLET	216, 235, 261 (Fits 1951 & earlier & 1955-57 bodies)	—	52-0015
	216, 235, 261 (Fits 1952-54 & 1958 & later bodies)	—	52-0025
	194, 215, 230, 250, 292, (automatic only)	1	(new) 52-0014
	194, 215, 230, 250, 292	(A)	(new) 52-0011
FORD	194, 215, 230, 250, 292	(B)	52-0020
	215, 223, 262, (truck only)	—	53-0020
	240, 300, (van & 4 w/d only)	—	(new) 53-0015
MOPAR	240, 300	—	53-0010
	198,225 (only)	12	55-0010
	198,225	11	55-0020

Notes: (A) Fits all trucks and passenger cars from 1955 up. Front header exits over the side motor mount.

(B) Fits all trucks and passenger cars 1954 and older. Front header exits straight down between motor mount and alternator. (does not fit with generators)





# GASKETS



## HEADER / INTAKE MANIFOLD

DESCRIPTION	SINGLE PART NO.	DESCRIPTION	SINGLE PART NO.
AMC JEEP 199,232,258	67-0016	FORD,PINTO,CAPRI 1600cc	63-0208
AMC JEEP 232,258 (small port 1972 & later)	67-0080	FORD,PINTO,CAPRI 2000cc	63-0272
AMC JEEP 151 (4cyl.) 1980 & Later (GM engine)	67-0151	FORD,CAPRI 2600cc (V6) (4 piece gasket)	63-0336
AMC JEEP "F" HEAD 134 (4cyl.)	67-0144	FORD,PINTO,MUSTANG II,CAPRI,RANGER 2300cc	63-0400
AMC JEEP 150 (4cyl.) 1984 and later	67-0155	FORD,MUSTANG II,CAPRI 2800cc (V6) 90° block	63-0464
AMC JEEP 242 (4.0 liter E.F.I.) 1987 & later	67-0176	FORD,COURIER 1800cc square port	63-0528
		FORD,COURIER 1800, 2000cc round port	63-0532
<b>BRITISH LANDROVER</b>	<b>60-0256</b>	GMC 248,270,302	62-0628
<b>BUICK, OLDS, PONTIAC 225,231,(V6)</b>	<b>61-0048</b>	GMC S-15 2800cc V-6	62-0600
CHEVY 216,235,261	62-0032	GMC S-15 151 4cyl. (crossflow '79-& later)	67-0151
CHEVY 194,230,250,292	62-0096	INTERNATIONAL SCOUT 152,196	67-0208
CHEVY - VEGA 2300cc	62-0160	ISUZU 1800,1900cc	62-0440
CHEVY 163 (4cyl.)	62-0224	ISUZU TROOPER II 2300cc (1981 up)	60-0100
CHEVY 250 Header only (new design) 1975-78	62-0288	MOPAR 170,198,225	66-0048
CHEVY 250 Block Off Plate (1975-78)	62-0352	MOPAR 2600cc (silent shaft)	66-0096
CHEVY 250 Header only (4 port design) 1979-84	62-0250	MOPAR 1600cc (square port only)	66-0192
CHEVY 250 Block Off Plate 1979-84	62-0300	MOPAR 2000cc (Colt engine)	66-0144
CHEVY LUV 1800cc	62-0416	MOPAR 2200cc	66-0150
CHEVY LUV 1800,1900cc (cross flow head)	62-0440	PONTIAC OHC 230,250	66-0032
CHEVY S-10 2800cc V-6	62-0500	PONTIAC OHV 215,250	62-0096
DATSUN 240,260	60-0000	PONTIAC 151 4cyl. (crossflow '79 & later)	67-0151
DATSUN 280Z (1976 only) F.I. head w/sq. exh. ports	60-0060	SUZUKI SAMURI (1983 up)	60-0300
DATSUN 280Z & ZX (1977-80) F.I. head w/rd. exh. ports	60-0064	TOYOTA LANDCRUISER (1960-67)	60-0128
DATSUN 1600 thru 2000cc square port	60-0260	TOYOTA LANDCRUISER (1968 & Later)	60-0192
DATSUN 1600 thru 2000cc round port	60-0264	TOYOTA 1600cc (O.H.V.)	60-0170
DATSUN Nap-Z 2000-2200cc	60-0265	TOYOTA 1900 - 2000cc (1971-74)	60-0160
FORD 216,223,262	63-0016	TOYOTA 2200cc (20R) (1975 & Later)	60-0150
FORD 144,170,200,250	63-0080	VOLVO 1800, 2000cc (1962-75)	60-0384
FORD 240,300	63-0144		

## Mandrel "U" Bends (180 Degree Bends)

### TECH NOTE:

Mandrel bending guarantees wrinkle-free bends and consistent inside diameter for maximum air flow. All primary head pipes should be made from mandrel bends to allow **MAXIMUM** air flow, without extra restrictions. Ordinary U-Bends have various sizes of inside diameter causing restrictions to air flow. Our U-Bends come in 3 sizes with short to extra long legs to reduce cutting and welding time of the "DO IT YOURSELF" header maker.

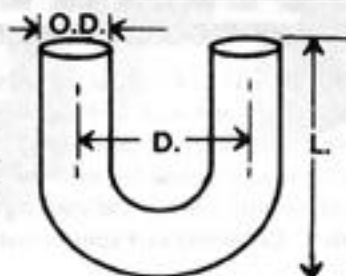

PART NO.	TUBE O.D.	DIM. "D"	DIM. "L"	Sh.Wt.
78-0224	1-1/2"	5"	9"	2 lbs.
78-0352	1-1/2"	5"	18"	3 lbs.
78-0416	1-5/8"	6"	9"	2 lbs.

PART NO.	TUBE O.D.	DIM. "D"	DIM. "L"	SH.Wt.
78-0544	1-5/8"	6"	18"	3 lbs.
78-0608	1-3/4"	6"	9"	3 lbs.
78-0736	1-3/4"	6"	18"	3 lbs.



## EXHAUST MUFFLERS

The CLIFFORD GLASS PACK Universal Muffler Core is a 30" long 2" I.D. muffler designed for low back pressure and universal installation. \*

The CLIFFORD TURBO is a Hi-Flow low back pressure muffler. This muffler is NOT recommended for dual application on inline engines due to excessive sound level. Best for single header outlet usage.

DESCRIPTION	LENGTH	PIPE SIZE	PART No.
CLIFFORD TURBO	14-1/2"	1-3/4"	78-2272
	14-1/2"	2"	78-2336
	14-1/2"	2-1/4"	78-2400
	14-1/2"	2-1/2"	78-2420
CLIFFORD GLASS PACK	30"	2"	78-2464

\* NOTE: Two glass packs work well for street usage in place of stock mufflers.



• See Page 4 for proper selection of mufflers.



# Header Components



## FLANGE KITS

ENGINE SIZE	FLANGE THICKNESS	FLANGE ONLY PART NO.	PART No's. - FLANGE KITS w/PRE-WELDED STUBS			
			PRIMARY HEAD PIPE SIZES			
			1-3/8"o.d.	1-1/2"o.d.	1-5/8"o.d.	1-3/4"o.d.
AMC 199,232,258 (1965-71 lge. port)	3/8"	77-0048	_____	_____	77-0304	77-0368
AMC 232,258 (1972-up small port)	3/8"	77-0112	_____	77-0240	_____	_____
AMC 150 (4 cyl. 1984 up)	3/8"	77-0115	_____	77-0215	77-0225	_____
AMC 242 (4.0 liter) (new)	3/8"	77-0117	_____	77-0216	77-0226	_____
BUICK, OLDS, PONTIAC 225,231 V-6	5/16"	71-0016	_____	71-0080	_____	_____
CHEVY 216,235,261	3/8"	72-0000	_____	72-0448*	_____	72-0448*
CHEVY 194,230,250,292	3/8"	72-0064	_____	72-0520	72-0512	72-0576
CHEVY VEGA 2300cc	1/4"	72-0256	_____	72-0768	_____	_____
CHEVY 4 cyl. 153 cid & 151 non/C.F.	3/8"	72-0320	_____	72-0896	72-0832	_____
CHEVY 4 cyl. 181 (marine eng.)	3/8"	72-0181	_____	72-0200	72-0300	72-0400
DATSUN 240,260,280Z	1/2"	70-0032	_____	70-0352	70-0416	_____
DATSUN 280Z (round port)	1/2"	70-0096	_____	70-0128	_____	_____
FORD 215,223,262	1/2"	73-0048	_____	73-0560	_____	_____
FORD 144,170,200,250	5/16"	73-0112	_____	73-0624	_____	_____
FORD 240,300	3/8"	73-0176	_____	_____	73-0688	73-0752
FORD PINTO, CAPRI 1600cc	1/4"	73-0240	73-0816	_____	_____	_____
FORD PINTO, CAPRI 2000cc	1/4"	73-0304	_____	73-0880	_____	_____
FORD PINTO, MUST. II 2300cc	5/16"	73-0368	_____	73-0944	_____	_____
FORD PINTO, CAPRI, MUST. II 2800cc V-6	5/16"	73-0496	_____	73-1072	_____	_____
FORD CAPRI 2600cc V-6	1/4"	73-0432	_____	73-1008	_____	_____
GMC 248,270,302, 6 cyl.	3/8"	72-0384	_____	72-0960*	_____	72-0960*
MOPAR 170,198,225	1/2"	75-0016	_____	75-0144	75-0080	_____
PONTIAC 151, 4 cyl. crossflow head	3/8"	76-0010	_____	76-0100	76-0200	_____
PONTIAC OHC 230,250	3/8"	76-0000	_____	76-0128	76-0064	_____

\*Flange kit has 2 pipe sizes ( 1-1/2" & 1-3/4" ) because of the siamese port design

## HEADER COLLECTORS

( SOLD IN PAIRS ONLY )

DESCRIPTION	3 INTO 1 COLLECTORS WITH FLANGE RINGS		
	1-1/2"	1-5/8"	1-3/4"
PRI. TUBE SIZE	1-1/2"	1-5/8"	1-3/4"
PART No.	78-1632	78-1696	78-1760
DESCRIPTION	3 INTO 1 COLLECTORS WITHOUT FLANGE RINGS		
	1-1/2"	1-5/8"	1-3/4"
PART No.	78-1184	78-1248	78-1312



COLLECTORS



STREET HOOK-UPS

## STREET HOOKUPS \*Sold in pairs only

( COMES COMPLETE WITH GASKETS, BOLTS & NUTS )

PART No.	DESCRIPTION
58-0042*	2-1/2" dia. collector 2-1/4" dia. pipe (3 bolt)
58-0032*	2-1/2" dia. collector 2" dia. pipe (3 bolt)
58-0096	2" dia. collector to 2" dia. pipe (2 bolt)
58-0160*	2-1/2" dia. collector to 1-3/4" dia. pipe (3 bolt)
COLLECTOR GASKETS 2-1/2" I.D. 3 bolt. 68-0000*	

**CARBURETOR-EXHAUST  
HEAT PLATE KIT**

CLIFFORD 2 and 4 BARREL MANIFOLDS ONLY

This is a **MUST ITEM** for all cars in cold climates (+60° F to -20° F). This plate bolts on to the bottom of the Clifford 2 or 4 barrel intake manifold. When installed with headers, will put exhaust gas to the bottom of the intake manifold in a similar manner to a stock O.E.M. manifold, but our **ALUMINUM** manifolds get hotter about 3 times faster than O.E.M. cast iron manifolds, thereby requiring less heat to warm the fuel in the manifold. If you live in colder climates (-20° F to -40° F), use Thermo Base Plates P/N 08-1888 or P/N 08-1856 along with Exhaust Heat Plate which comes complete with bolts, gaskets, line fittings, weld-on header fitting and 24" of 3/8" copper tubing, plus installation instructions.

PART No. 08-1900

**THERMO BASE PLATES**

2 and 4 BARREL APPLICATIONS

A **MUST ITEM** for all vehicles equipped with headers and operated in cold climates (+60° F to +10° F). For colder climates, use Carb Exhaust Heat Kit P/N 08-1900. (see this page) These Thermo Base Plates take the "chill" off the carburetor, thus eliminating sluggish operation in cold weather. Easily installed. Fits between carb mounting plate and the manifold. Hot water (from the heater hose) warms the spacer, manifold and carb.

PART No. 08-1888 2-barrel Holley Base (3-1/2" x 5-1/8")

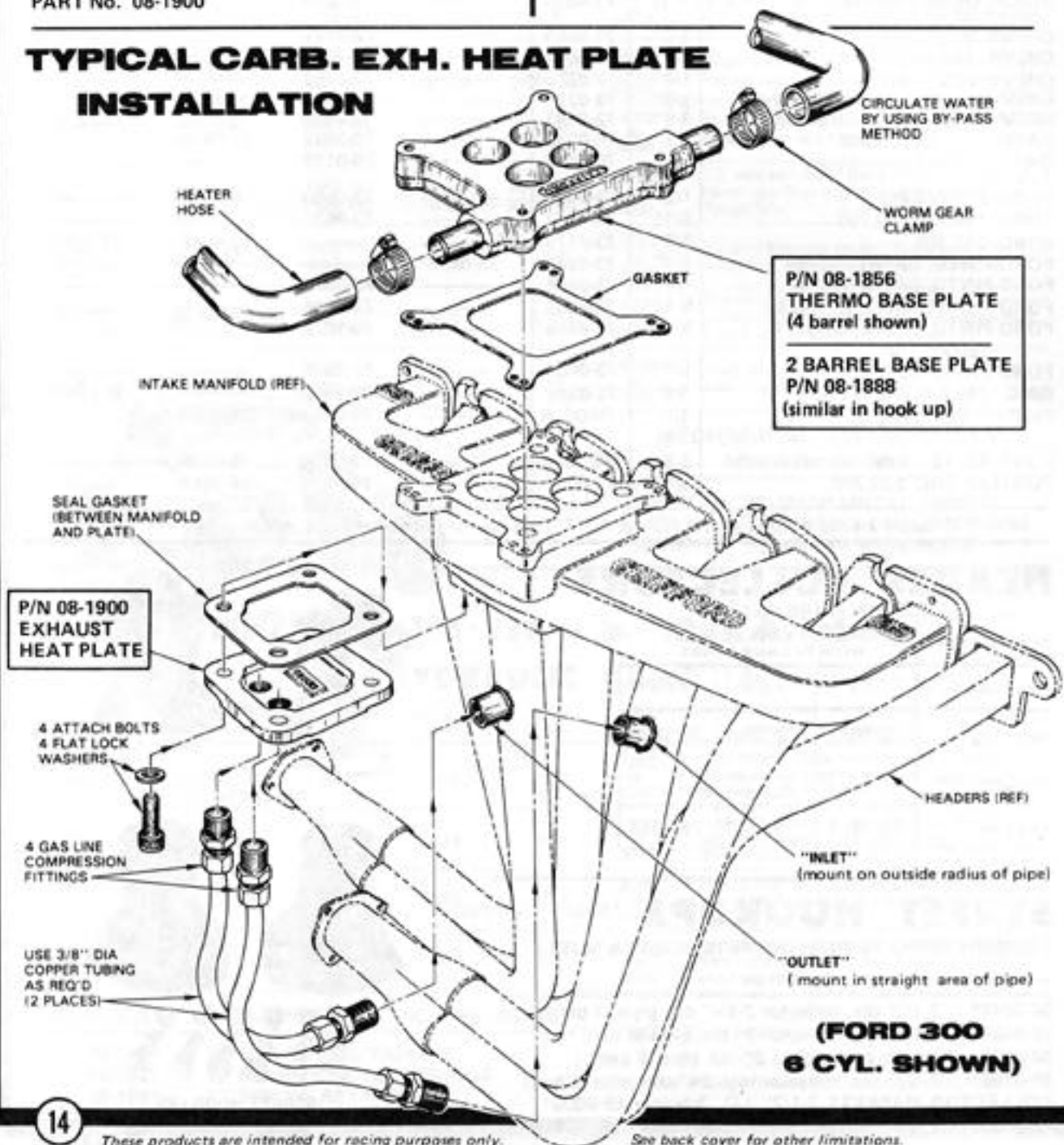
PART No. 08-1856 { 4-barrel Holley Base (5-1/8" x 5-5/8")  
4-barrel Carter Base (4-1/4" x 5-5/8")**TYPICAL CARB. EXH. HEAT PLATE  
INSTALLATION**

• NOTE:  
MANIFOLDS SHOWN  
WITH MOUNTING  
PLATES  
(not included)

## RAM-FLOW 2 & 4 BARREL MANIFOLDS

The Clifford Performance Ram-Flow 4 Barrel Manifold was primarily designed as a performance intake, but with the recent development of small four barrel carburetors (390-400.cfm) the 4 barrel intake assembly has proven to be the ultimate low R.P.M. assembly for today's six cylinder engines. The small 4 barrel carb and manifold actually gets better mileage and more power than most 2 barrel carbs.

The Clifford Performance Ram-Flow 2 Barrel Intake Manifold has been designed to increase the performance and driveability of your vehicle and, at the same time, retain (and in most cases, improve) good fuel economy. This has been accomplished by attaining equal fuel-air distribution to each cylinder.

### BASIC MAN.FOLDS **without** Base Plates

		PART No.
CHEVROLET	235,261 cu. in.	42-4500
	194 thru 292 cu. in.	42-4501
	153 cu. in.	42-4506
GMC	248, 270, 302 cu. in.	42-4507
FORD	223,262 cu. in.	43-4501
	240,300 cu. in.	43-4502
MOPAR	170,198,225 cu. in.	45-4500
PONTIAC	OHV 215,250 cu. in.	42-4501
	OHC 230,250 cu. in.	46-4500
AMC/JEEP	199,232,258 cu. in.	47-4500
	242 cu.in. (4.0 liter) 1987-91	47-4510
	242 cu.in. (4.0 liter) 1992 up (new)	47-4520
GM CARS & AMC	151 cu.in.(crossflow only)	42-4508
TOYOTA Landcruiser	236, 258 cu.in. ('75 & later)	40-0640

(See below for  
Mounting Plates)

### CARBURETOR MOUNTING PLATES

	PART No.
2 Barrel universal	08-1013
4 Barrel universal	08-1014
4 Barrel Holley Spreadbore	08-1024

See Page 17 for details of  
Carburetor Mounting Plates

#### RECOMMENDED 2 BARREL HOLLEY CARBS (2300) Series

STREET ENGINES	280 CFM	P/N 08-2205
	350 CFM	P/N 08-2305*
	500 CFM	P/N 08-3305*
RACE ENGINES	500 CFM	P/N 08-4412
	650 CFM	P/N 08-6425

\*(2305 series 2 stage carbs)

#### RECOMMENDED 4 BARREL CARBS HOLLEY (4160) Series

STREET ENGINES	150 to 300 cu. in.	P/N 08-8007 (390 CFM)
		P/N 08-1848 (465 CFM)
RACE ENGINES	230 to 290 cu. in.	P/N 08-4776 (600 CFM)
	290 to 350 cu. in.	P/N 08-4778 (700 CFM)

• NOTE: All Clifford Manifolds have been designed to be used in conjunction with EXHAUST HEADERS ONLY. Will not fit with stock exhaust manifold.

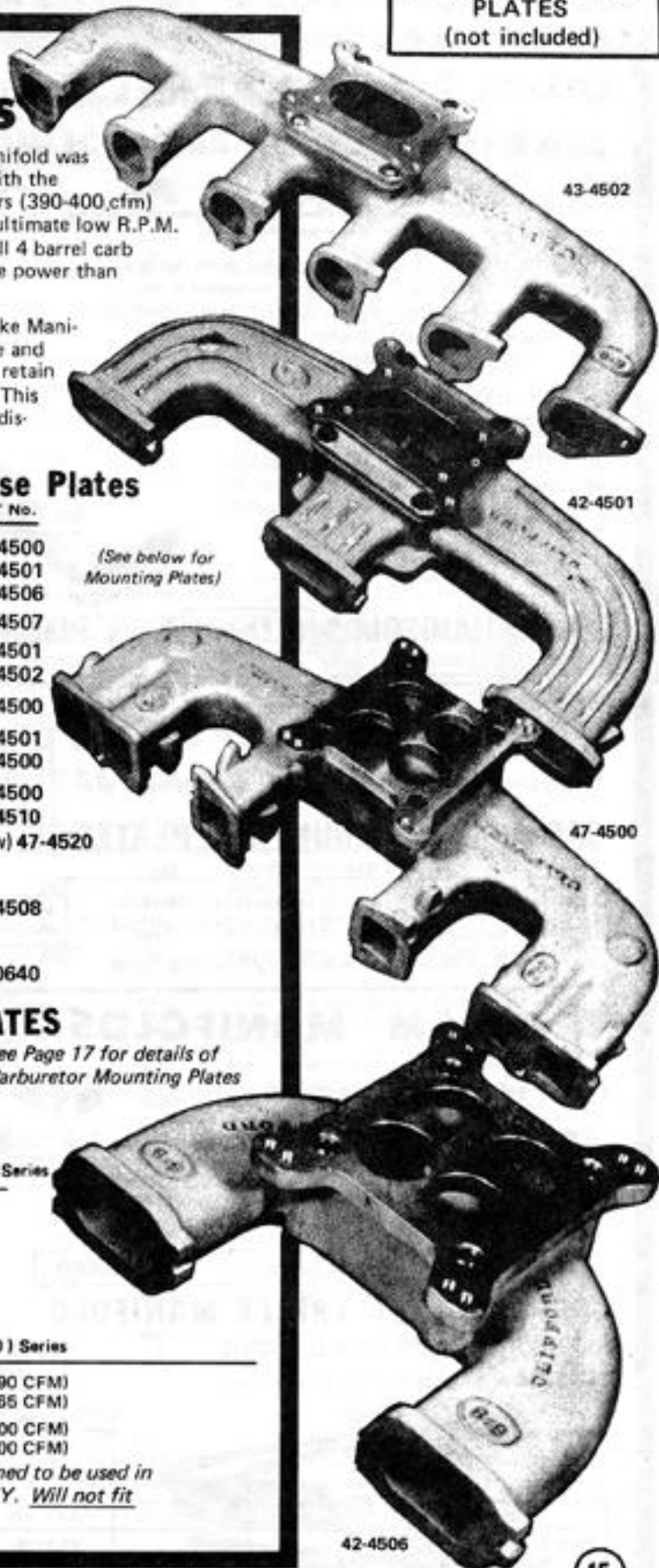

These products are intended for racing purposes only. See back cover for other limitations.

NOTE: SEE PAGE 22 FOR WATER-HEATED MANIFOLDS

• NOTE:  
MANIFOLDS SHOWN  
WITH MOUNTING  
PLATES (not included)

## DUAL 2 & 4 BARREL MANIFOLDS

### COMPETITION & SUPER STREET

The Clifford Dual 4 Barrel Manifold has been designed as a high performance intake system intended primarily for drag race use. These manifolds incorporate removable carb mounting plates which enable you to convert your manifold to a dual 2 or 4 barrel assembly.

The Clifford Dual 2 Barrel Manifold is very popular in circle track applications where rules limit carburetion to dual 2 barrel carbs.

All Clifford Dual 4 Barrel Intake Manifold systems are cast from prime aluminum and are supplied with all carb linkage and hardware needed for installation.



42-4650

42-4650

### BASIC MANIFOLDS **without** Base Plates

		PART No.
CHEVROLET	194,230,250,292 cu. in.	42-4650
FORD	240,300 cu. in.	43-4650
PONTIAC	OHV 215,250 cu. in.	42-4650

These can be used with any Base Plate listed below

• NOTE:  
Carb linkage  
included

### CARBURETOR MOUNTING PLATES

	Part No.	
2 Barrel (new)	08-1013	2 required per manifold
4 Barrel	08-1014	2 required per manifold

Mounting Plates for  
above manifolds

See Page 17 for details of Carburetor Mounting Plates

## TRI-RAM MANIFOLDS

### TRIPLE TWO BAREL MANIFOLD

The Clifford Tri-Ram series of manifolds are primarily designed for race car applications where the engine RPM is maintained above 4500 at all times. We recommend using three Holley 500 CFM 2 barrel carburetors, P/N 08-4412

NOTE: No linkage supplied.

		PART No.
FORD	240,300 cu. in.	43-2000

43-2000

### OFFY STREET TRIPLE MANIFOLD

FALCON, COMET & MUSTANG

1960 and later (OFFY 43-2192 design)

This Offenhauser Triple carburetor manifold is marketed as a progressive 3 one barrel carb system. It comes complete with installation kit. Can be used with standard or automatic transys but A Mallory distributor is recommend.

BODY STYLE	ENGINE SIZE	PART NO.
Ford & Comet (1961-69)	170,200	43-2128
Ford/Maverick & Comet (1970 & later)	170,200,250	43-2192

• NOTE:  
Carb linkage  
included

43-2192

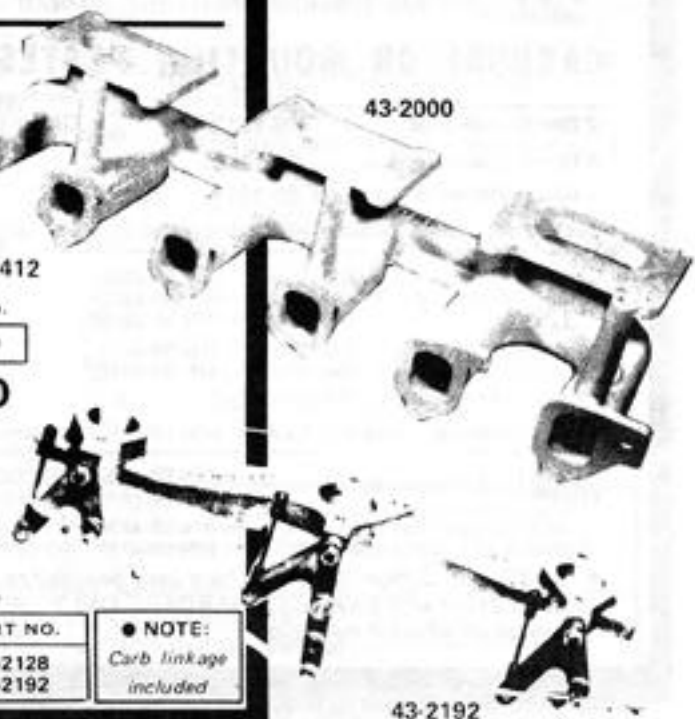



**CARBURETOR ADAPTER** HOLLEY 2300 SERIES**2 BARREL CARB TO 1 BARREL MANIFOLD**

Adapts any large base 2 barrel carburetor (Holley 280, 350, 500 and 650 cfm) to your stock 1 barrel manifold. Ideal, and very popular in circle track racing when class rules prohibit the use of a Clifford Performance ram-flow intake. 2 barrel pattern 3-1/2" x 5-1/8". 1 barrel pattern **NOT** drilled. (You drill it)

PART No. 08-1600

**HOLLEY / WEBER ADAPTER** 5200 & WEBER  
DGV SERIES**2 BARREL CARB TO 1 BARREL MANIFOLD**

Adapts the popular Holley/Weber 5200 series 2 barrel carb to your stock 1 barrel manifold. Made for small engines that need more power without loss of mileage. 2 barrel pattern 1-13/16" x 3-5/8". 1 barrel pattern **NOT** drilled. (You drill it)

PART No. 08-1610

**CARBURETOR SPACER****1" and 2" HIGH-RISE SPACER**

Designed to be used on Clifford ram-flow manifolds only. Intended as a fine tuning device to be used when everything else is right. This spacer will usually lean the fuel mixture slightly and in high velocity applications will allow the air and fuel to mix more completely. Complete with all hardware and gaskets. Fits between carb mounting plate and manifold casting.

1" Spacer PART No. 08-1662

2" Spacer PART No. 08-1664

**CARBURETOR MOUNTING PLATE****Universal** 2 BARREL CARB TO CLIFFORD MANIFOLD

Each Clifford ram-flow manifolds consists of two pieces; the manifold and a carburetor mounting plate. This mounting plate allows you to convert your Clifford manifold from a 4 barrel to a 2 barrel in a matter of minutes. The carb bolt pattern is designed to accept a large flange 2 barrel 2300 series carburetor (3-1/2" x 5-1/8") or a small 5200 series carburetor (1-13/16" x 3-5/8") also Weber DGV series too.

PART No. (new) 08-1013 • can be mounted in any forward or 90° position

**CARBURETOR MOUNTING PLATE****Universal** 4 BARREL CARB TO CLIFFORD MANIFOLD

Each Clifford ram-flow manifold consists of two pieces; the manifold and a carburetor mounting plate. This mounting plate will allow you to remove a 2 barrel carb and install a 4 barrel carb in a matter of minutes, and will accept any Holley or Carter AFB with a square bolt pattern. (Carter 4-1/4" x 5-5/8"; Holley 5-1/8" x 5-5/8")

PART No. 08-1014 • can be mounted in any forward or 90° position

**CARBURETOR MOUNTING PLATE****Universal** SPREAD-BORE, QUADRA-JET OR THERMO  
QUAD TO A CLIFFORD MANIFOLD

Each Clifford ram-flow manifold consists of two pieces; the manifold and a carburetor mounting plate. This mounting plate will allow you to use any Spread-Bore, Quadra-Jet or Thermo-Quad 4 barrel carburetor to Clifford manifold (Holley S.B., Rochester Q.J. or Carter T.Q. bolt pattern of 5-5/8" x 4-1/4").

PART No. 08-1024 • can be mounted in any forward or 90° position



## SIDE DRAUGHT WEBER MANIFOLDS

The Clifford Side Draught Manifolds, when equipped with DCOE Weber carburetors, make up the ultimate and most versatile induction system available. The installation of this type of induction system can net a 40 to 60 horsepower increase over the stock intake system and will lengthen the torque range of the engine by 1500 to 1800 RPM, thus providing excellent mid-range power.

All Clifford Side Draught Manifolds are cast from prime 356 T6 aluminum and are supplied with a throttle cross shaft and linkage arms.

• **NOTE:** 45 DCOE series carbs recommended

		PART No.
CHEVROLET	194 thru 292 cu. in.	42-3040
	153 cu.in. (4 cyl.)	42-3168
FORD	240,300 cu.in. (side draught)	43-3024
	240,300 cu.in. (down draught)	43-3152
GMC	248,270,302 c.i.d.	42-4850
MOPAR	170,198,225 cu. in.	45-3056
PONTIAC	OHV, 215,250 cu. in.	42-3040
	OHC, 230,250 cu. in.	46-3040
AMC/JEEP	199,232,258 cu. in.	47-3024
	150 cu.in. 4 cyl. (1984 & later)	47-3025

**NOTE:** Modification to headers may be required except when using "STREET ROD" HEADERS

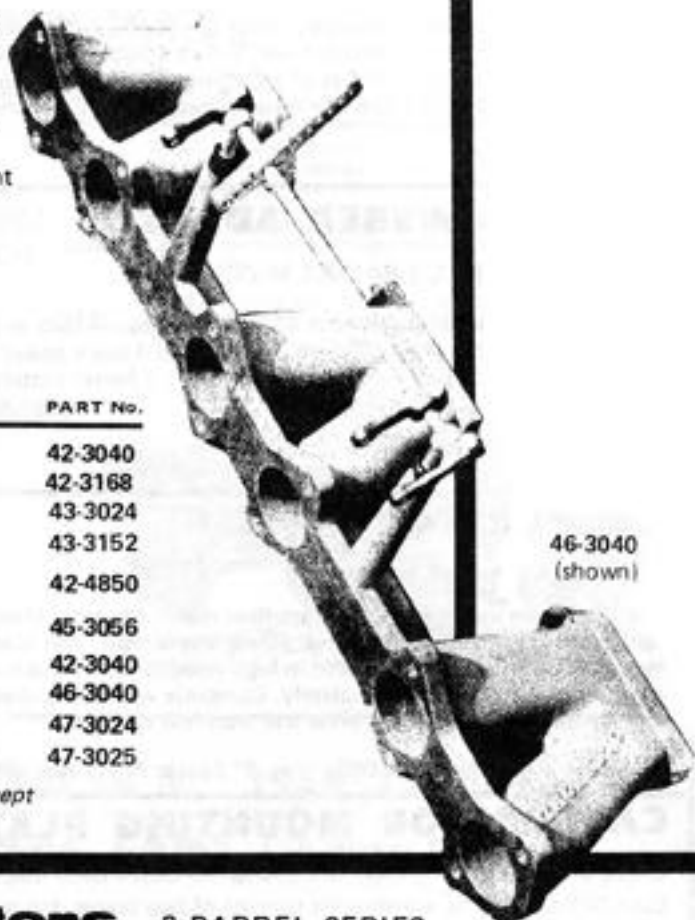

46-3040  
(shown)

## WEBER Carburetors 2 BARREL SERIES

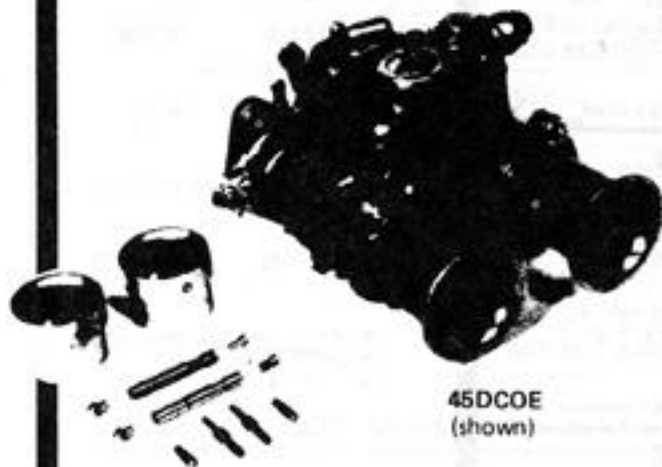

45DCOE  
(shown)

WEBER MODEL NO.	VENTURI SIZE (mm) Available	NOTES	PART NO.	SH. WT.
45 DCOE (Side Draught)	32-40	see tech. note below	08-3136	8 lbs.
48 IDA 4 (Down Draught)	36-45	see tech. note below	08-3328	8 lbs.
DGEV series (progressive)	32/36	see note 1	08-7033	8 lbs.
DGES series (synchroness)	38/38	see note 2	08-7038	8 lbs.

**NOTES:** 1. The DGV series carb. is a progressive 2 stage opening, to 320 cfm, used for small engines under 260 cu.in. with mileage as a prime objective yet with more H.P.

2. The DGES series carb. with manual choke is a straight 2 barrel carb. with an opening of 360 cfm. This is the best power choice for mid-size engines up to 290 cu. in. Special linkage kits are available. see linkage page.

**TECH NOTE:** Weber side draught or down draught carburetors are the world's most versatile carburetors. They are really injectors with brains. The Weber carburetor is fully adjustable and can be tuned for any size engine regardless of usage. All jets and venturis are changeable without removing the carb from the manifold. A set of 3 side draught carburetors on any 6 cylinder engine will put out more HP than any other carburetion made. The two basic types of Weber carburetors are the SIDE DRAUGHT and DOWN DRAUGHT models. Side draught Weber carbs are best suited for Inline 6 cylinder engines because of direct port flow. Down draught Weber carbs are best for V-8 and 2 barrel limit carburetion adapted to single quad manifolds for racing

CARBURETOR PARTS for 40, 42 and 45 DCOE and 48 IDA CARBS ONLY AIR CORRECTOR JETS (All models)	SIZES (Millimeters) (Add Size After P/N When Ordering)	PART NO.	SH. WT.
	1.30, 1.40, 1.50, 1.55, 1.60, 1.70, 1.75, 1.80, 1.85, 1.90, 2.00, 2.05, 2.10, 2.20, 2.25, 2.30, 2.40, 2.50, 2.60, 2.70, 2.75, 2.80, 2.90, 3.40	08-4032	6 oz.
IDLE SPEED JETS (All models) <b>NOTE:</b> State series and size when ordering. Rich starts with (F-6) and goes to leanest with (F-3) series	(F-6).40,.45,.50,.55,.60,.65,.70,.80,.90,1.00; (F-9).30,.40,.45,.50,.55,.60;(F-8).40,.45,.50,.55,.60;(F-11).40,.45,.50,.55,.60;(F-13).50; (F-2).40,.45,.50,.55,.60,.65,.70,.80;(F-4).40,.45,.50,.60;(F-5).40,.45,.50,.60,.65;(F-3).40,.45,.50,.55	08-0573	3 oz.
MAIN JETS (All models)	1.30, 1.35, 1.40, 1.45, 1.50, 1.55, 1.60, 1.65, 1.70, 1.75, 1.80, 1.85, 1.90, 2.00, 2.05, 2.10, 2.15, 2.20, 2.25, 2.30, 2.35, 2.40, 2.45, 2.50.	08-4016	3 oz.
CHOKE, PRIMARY VENTURI (45 DCOE) CHOKE, PRIMARY VENTURI (48 IDA)	30, 32, 33, 34, 35, 36, 37, 38, 40 36, 37, 40, 42, 45	08-4336 08-4344	5 oz. 6 oz.
EMULSIONING TUBES (All models)	F-1, F-2, F-3, F-4, F-5, F-6, F-7, F-8, F-9, F-10, F-11, F-12, F-14, F-15, F-16, F-17, F-19, F-20	08-0576	3 oz.
PUMP JET With gasket (40, 42, 45 DCOE) PUMP JET With gasket (2)(48 IDA only)	0.35, 0.40, 0.45, 0.50, 0.55, 0.60, 0.65, 0.70, 0.75 0.40, 0.50, 0.60, 0.70	08-4208 08-4216	1 oz. 1 oz.
MISCELLANEOUS WEBER ACCESSORIES & PARTS			
COVERS, AIR HORN: Plastic dust covers for all 42 & 45 DCOE carbs (1 required per carb)		08-4886	6 oz.
COVERS, AIR HORN: Plastic dust covers for all 48 IDA carbs (1 required per carb)		08-4888	6 oz.
GASKET KIT, CARBURETOR overhaul set for DCOE series		08-4784	6 oz.
GASKET KIT, CARBURETOR overhaul set for 48 IDA series		08-4788	6 oz.
GASKET KIT, CARBURETOR overhaul set for DGV series		08-4790	6 oz.
LEVER, THROTTLE control for DCOE carbs only (universal type)		08-4836	6 oz.
FUEL PRESSURE REGULATOR, HIGH FLOW with 3/8" pipe inlet & outlet. Adjustable from 0 to 7 p.s.i.		08-5084	1 lb.
GASKET, CARBURETOR BASE, DCOE SERIES (2 required per carb)(soft mount type)		08-4772	6 oz.
GASKET, CARBURETOR BASE, 48 IDA SERIES (2 required per carb)(soft mount type)		08-4776	6 oz.
MANUAL, GUIDE TO TUNING with 51 pages of tuning hints for Weber. Tells how to select the correct jet and tune it.		08-4928	8 oz.



## AIR CLEANERS & ACCESSORIES

WEBER CARB AIR CLEANERS - DESCRIPTION	PART NO.	SH. WT.
<b>AIR CLEANER DCOE FLAT SERIES.</b> Small flat street model for all Weber side draft carbs. K&N filter design, all Weber side draft carbs. K&N filter design, height 57mm but Air Horns must be removed when using this air cleaner.	08-7044	3 lbs.
<b>AIR CLEANER DCOE TALL FLAT SERIES.</b> This street model allows the use of Air Horns. K&N filter design, height 85mm.	08-7068	3 lbs.
<b>AIR CLEANER IDA SERIES.</b> This flat street model is used for Weber 48-IDA downdraft carb. <b>Note:</b> Air horns need not be removed K&N filter design, height 128mm	08-7088	3 lbs.
<b>AIR CLEANER DGV SERIES.</b> This model is used for best hood clearance with DGV series carb. Height with air cleaner & carb is 5". Air cleaner height is 1-7/8".	08-7084	3 lbs.
<b>AIR CLEANER DGV STANDARD SERIES.</b> Same as above design (08-7084) except height is 2-5/8".	08-7083	3 lbs.
DGV THROTTLE LEVER KITS		
<b>WEBER DGV THROTTLE LEVER KITS</b> Cable throttle lever adapter allows the use of any cable throttle with DGV Weber carburetor & DGES Carb.	08-7116	1 lbs.
Rod throttle adapter allows the use of any rod operated throttle to be used with DGV Weber carburetor. (will not fit DGES Carbs.)	08-7115	1 lbs.

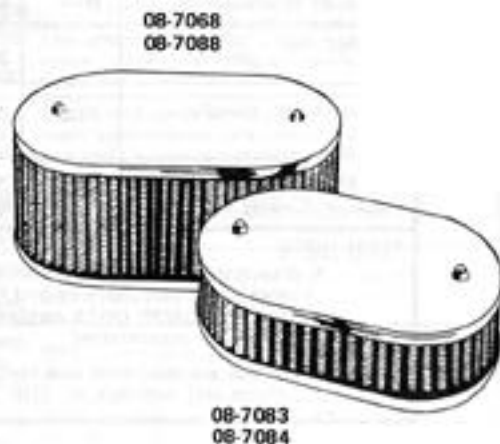

## CARBURETOR SYNCHRONIZER

The UNI-SYN carburetion synchronizer gauge is a MUST for tuning of any multi-carb system. No jetting can be done until all carburetors are synchronized as one unit. The UNI-SYN gauge allows quick and exact synchronizing by visual readings.

DESCRIPTION	PART NO.	SH.WT.
SINGLE and 2 BARREL CARB GAUGE	08-5312	1 lb.





# FUEL SYSTEMS

## WEBER CARBURETOR PERFORMANCE KITS FOR AMC/JEEP, GM V-6 2.8 liter ISUZU, SUZUKI & TOYOTA L.C. VEHICLES



MAKE/ENGINE	YEAR	KIT INCLUDES	TRANSMISSION		PART NO.	NOTES
			STICK	AUTO		
Jeep 4 cyl. 134 cid L&F head eng. w/carter YF one barrel carb.	1945-69	32/36 DGV carb, adapter linkage & air filter.	X	—	08-K553	Manual choke, universal linkage for cable option. (cable not included)
Jeep 4 cyl. GM 151 cross-flow head w/2SE & E-2 SE Rochester 2 brl. carb.	1980-83	32/36 DGEV carb, adapter, linkage, air filter &	X	X	08-K491	Mileage carb. plus 12% more HP & electric choke
		38 DGES carb. plus kit.	X	X	08-K490	Power carb. 18% more HP w/electric choke.
Jeep 4 cyl. AMC 150 cid eng. w/carter YF/FA series one barrel carb.	1984-up	32/36 DGEV carb, adapter, linkage & air filter.	X	(1)	08-K552	Electric choke, (if used with automatic trans. use linkage kit no. 08-K007) (1)
Jeep 6 cyl. 232 cid eng. w/carter YF/YFA series one barrel carb.	1972-78	32/36 DGEV carb, adapter, linkage & air filter.	X	X	08-K550	Electric choke, (if used with automatic trans. use linkage kit no. 08-K007) (1)
Jeep 6 cyl. 258 cid eng. w/carter BBD series 2 barrel carb.	1972-up	32/36 DGVE carb, adapter, linkage & air filter.	X	X	08-K551	Electric choke, (if used with automatic trans. use linkage kit no. 08-K007) (1)
		38 DGES carb, plus kit.	X	X	08-K558	Power carb. 18% more HP w/electric choke.
Jeep V6 GM 173 cid eng. w/Rochester 2SE & E-2SE 2 barrel carb.	1984-85	38 DGES carb, adapter linkage & OEM air filter adapter.	X	X	08-K490	Electric choke, Best choice carb. for Power & mileage.
Isuzu 4 cyl. Trooper w/ 1.9 liter engine w/carb.	ALL	32/36 DGEV carb, adapter, linkage & air filter.	X	—	08-K696	Electric choke.
Trooper II w/2.3 liter engine w/carb. also fits Amigo too.	ALL	32/36 DGEV carb, plus kit.	X	—	08-K697	Electric choke
		38 DGES carb, plus kit.	X	—	08-K698	Electric choke.
Suzuki 4 cyl. Samurai	ALL	32/32 DGEV carb, adapter, linkage & air filter.	X	—	08-K601	Electric choke.
Toyota 6 cyl. Land-cruiser F series eng.	1968-up	32/36 DGEV carb, adapter, linkage & air filter.	X	—	08-K743	Electric choke, cable linkage required.

### TECH NOTE

1. The Weber 32/36 DGEV conversion kits for the AMC/JEEPS will give up to 18% more HP increase over stock OEM carb, as well and up to 10% to 20% in better fuel economy. For more plain HP there is the larger 38/38 DGES carburetor. What is sacrificed in fuel economy it more than makes up for better pick-up or acceleration.

All kits are pre-jetted and come with installation and tuning instructions plus carb. to manifold adapter, linkage and washable air filter. Average shipping weight is 8 lbs.

## CAGLE FUEL REGULATORS

**TECH NOTE:** The Cagle Fuel Regulator is a vacuum adjusted regulator. It raises and lowers the fuel pressure as you drive. It allows the fuel pressure to rise to 7 psi. at full throttle and lowers it to 1.5 psi. at idle and cruise.

- BENIFITS:**
- Up to 20% better mileage. Better driveability, no bogging or flooding.
  - Compensates for changes in altitude and vapor-lock.
  - Cures most off-road flooding due to cornering and accelerating.
  - Easy to install with most hand tools.
  - Street legal in California, CARB EXCEC. order NO. D-75-11

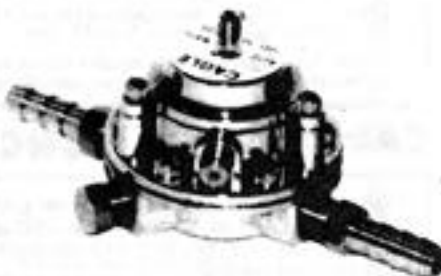

General purpose Domestic Carburetor Model.....PART NO. 08-1115

Foreign Carburetor (Weber & Mikuni) Model.....PART NO. 08-1140

**NOTE: CANNOT BE USED WITH FUEL INJECTION.**

4 - BARREL CARBURETORS	USAGE		ENGINE DISP.	CFM	PART NO.	SH. WT.
	STREET	COMP.				
HOLLEY 4 brl. 4160 series, electric choke, vac. secondaries, Ford A/T kick-down lever, PVC/spark vacuum ports.	YES	OPT.	150-300	390	08-8007	15 lbs.
HOLLEY 4 brl. 4160 series, hot air auto-choke, vac. secondaries, vac. ports.	YES	OPT.	200-300	465	08-1848	15 lbs.
HOLLEY 4 brl. 4160 series, manual choke, vac. secondaries, vac. ports.	YES	OPT.	290-up	600	08-1850	15 lbs.
2 - BARREL CARBURETORS						
HOLLEY 2 brl. 2300 series, hot air auto-choke, PVC/spark vac. secondaries,	YES	OPT.	150-300	280	08-2205	12 lbs.
HOLLEY 2 brl. 2300 series, manual choke, ctr. hung float, Ford A/T kick-down lever, PVC/spark vac. ports.	OPT.	YES	250-up	500	08-4412	12 lbs.

NOTE: Best street performance 2 barrel carburetor is the Weber 360 cfm DGES series. Use on engines of 200 cid or more. (See page 19 for more information).

MISCELLANEOUS HOLLEY ACCESSORIES & PARTS PLUS TUNNING NOTES *						
HOLLEY MAIN JETS* Std. sizes for all 2300 & 4160 carbs. ADD size after PN when ordering: 43, 44, 45, 46, 47, 48, 49, 50, 51, 52, 53, 54, 55, 56, 57, 58, 59, 60, 61, 62, 63.					08-0122	6 oz.
HOLLEY POWER VALVES, single stage, std. flow. Note: To determine correct size, measure manifold vacuum at idle and divide by 2 (i.e. 15" of vac, use 7.5 Hg. power valve)				5.0 Hg	08-2550	6 oz.
				6.5 Hg	08-2565	6 oz.
				7.5 Hg	08-2575	6 oz.
				8.5 Hg	08-2585	6 oz.
HOLLEY SECONDARY DIAPHRAGM SPRING KIT, a package of 7 springs for different openings. NOTE: Use with 390 cfm 4 barrel Holley on engines over 390 cid.					08-2012	1 lb.
HOLLEY DISCHARGE NOZZLE-TUBE TYPE, 2 pump jets per package. When using the 390 cfm 4 brl. Holley, use the .031 size jet for engines 225 to 260 cid; .035 for engines 290 or larger.				.028	08-2128	6 oz.
				.031	08-2131	6 oz.
				.035	08-2135	6 oz.

## AIR CLEANERS & ACCESSORIES

DOMESTIC CARB AIR CLEANERS - DESCRIPTION	PART NO.	SH. WT.
AIR CLEANER - LARGE 2 & 4 brl. SERIES. Fits carbs with 5-1/8" neck and with adapter fits 4-7/32" neck carbs. (Size 14" dia. x 3" high)	08-7212	5 lbs.
● REPLACEABLE PAPER ELEMENT	08-7216	2 lbs.
AIR CLEANER - TOP BREATHER SERIES. Fits all carbs listed in above P/N 08-7212. Size: 12" dia. x 3-3/4" high.	08-7232	5 lbs.
AIR CLEANER - MED. SIZE 2 & 4 brl. SERIES. Fits all carbs listed in above P/N 08-7212. Size: 9" dia. x 4" high.	08-7252	4 lbs.
● REPLACEABLE PAPER ELEMENT	08-7256	2 lbs.

NOTE: All Domestic Air Cleaners listed above are triple chrome plated, have paper elements and all have smog tubes.

## MECHANICAL THROTTLE & PEDAL KITS

DESCRIPTION	PART NO.	SH. WT.
<b>MECHANICAL THROTTLE &amp; PEDAL KIT</b> Kit includes attaching hardware. Standard cable length is 4 ft.	08-5136	3 lbs.
<b>FIREWALL MECH. THROTTLE &amp; PEDAL KIT</b> Kit includes attaching hardware. Standard length is 2 ft.	08-5152	3 lbs.
<b>CABLES ONLY</b> for 08-5136 & 08-5152 pedals		
4 foot long cables.....	08-5104	1 lb.
6 foot long cables.....	08-5106	1 lb.
8 foot long cables.....	08-5108	1 lb.
<b>CLIFFORD COMPETION 4 BRL. LINKAGE PLATE</b> This brkt. allows the stock throttle cable to be attached to the carb. mtg. plate bolts, therefore the cable will track the carb. no matter which direction the carb. is rotated. Bracket can be used with either round or square cable end design. It fits the Holley 4160 & AFB Carter carbs. A small adjustable brkt. for GM cable included. A Morse cable brkt. is available too. (Part No. 08-5334).	08-5162	2 lbs.
<b>CLIFFORD STREET 4 BRL. CARB LINKAGE BRKT. KITS:</b> These carb mounted cable linkage kits accept GM cables and are easy to mount to Holley & AFB carbs.		
<b>STANDARD TRANSMISSION</b> carb linkage bracket.	08-5619	1 lb.
<b>AUTOMATIC TRANSMISSION</b> carb linkage bracket.	08-5620	1 lb.
<b>NEW STANDARD TRANSMISSION</b> 2 or 4 barrel carb linkage. (new)	08-2418	1 lb.
<b>NEW AUTOMATIC TRANSMISSION</b> 2 or 4 barrel carb linkage. (new)	08-2428	1 lb.

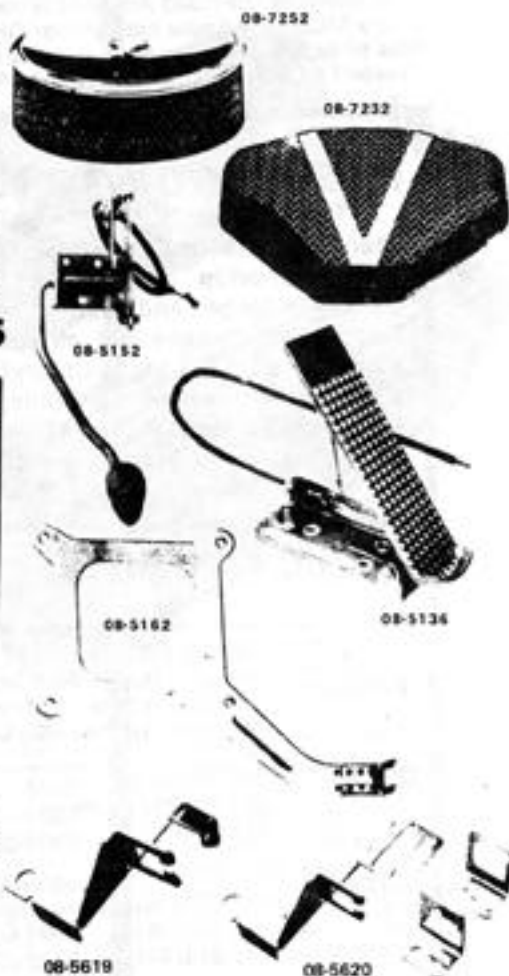

**new! MULTI-POINT & THROTTLE-BODY FUEL INJECTION**

Multi-Point Fuel Injection is the hottest and best H.P. item for any Inline 6. Up to 35% increase in H.P. and torque can be gained over stock carburetion. Most 6 cyl. engines can produce almost one H.P. per cubic inch when a street cam, headers and econoflow head work. These E.F.I. systems were developed exclusively for Clifford Performance by Turbo City

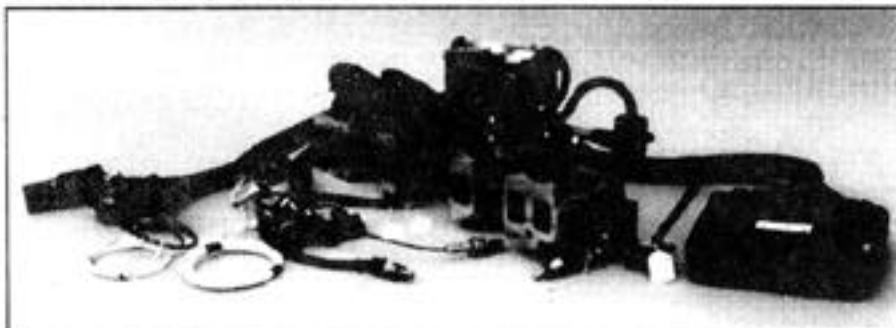

This system uses all GM components for reliability and is programmed to automatically adjust fuel A/R and ignition as required.

All systems M.P.I. or T.B.I. come complete with: GM computer, T.B.I. harness, sensors, injectors, fuel pump, intake manifold, adapters and misc. hardware. Installation instruction included also.

**BENEFITS:**

1. Excellent cold or hot starts and no engine stalls upon drive-away accelerations due to more even fuel/air ratio.
2. Automatic fuel flow adjustments for different altitudes or extreme Off-Road Angle of terrain. This requirement is a MUST for Snow cats and/or Off-road vehicles.

**HOW TO ORDER:** Choose the fuel system that fits most of your needs; T.B.I. or M.P.I. ALL SYSTEMS REQUIRE CLIFFORD MANIFOLDS.

MULTI-POINT FUEL SYSTEM	Part No.	Fuel-H.P. Avail.
AMC/Jeep 199, 232, 258	47-9100	225
AMC/Jeep 242 (4.0 liter) Pre-90	47-9200	240
AMC/Jeep 242 (4.0 liter) 91-up	47-9300	240
Chevy 194, 230, 250, 292	*42-9100	225
Ford 240, 300	*43-9100	225
Mopar 170, 198, 225	*45-9100	225
T.B.I. UNIVERSAL SYSTEMS	AVAILABLE SUMMER 1995	
2 barrel T.B.I.'s are available, on request. These systems will work with all 4, 6 or 8 cyl. engines with 2 barrel manifolds.		

\* Avail. Summer '95

**new!****WATER HEATED INTAKE MANIFOLDS**

These new "WATER-HEATED" intake manifolds are designed to work in all climates, provide better fuel vaporization, better mileage and better performance. Keeping the intake hot all the time, is a must for all T.B.I. injection and carbureted systems. These new manifolds, when used with exhaust headers will work like a stock intake/exhaust manifold, which is a must for colder climates.

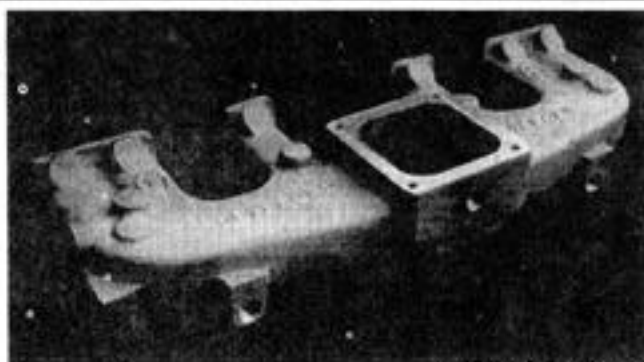

AMC-JEEP (SHOWN)

**BASIC MANIFOLDS without Base Plates**

	PART No.		PART No.		
AMC/JEEP	199, 232, 258 cu. in.	47-4500-WH	PONTIAC OHV 215, 250 cu. in.	42-4501-WH	
	150 cu. in. (4cyl.) 1984 & later	47-4501-WH	OHC 230, 250 CU. IN.	46-4500-WH	
	242 cu. in. (4.0 liter) 1987-1990	47-4510-WH			
	242 cu. in. (4.0 liter) 1991- Up	47-4520-WH	FORD 223, 262 cu. in.	43-4501-WH	
CHEVROLET	235, 261 cu. in.	42-4500-WH	240, 300 cu. in.	43-4502-WH	
	194 thru 292 cu. in.	42-4501-WH			
	153 cu. in.	42-4506-WH	MOPAR 170, 198, 225 cu. in.	45-4500-WH	
GM CARS & AMC	151 cu. in. (crossflow only)	42-4508-WH	<b>CARBURETOR MOUNTING PLATES</b>		
DATSUN	240, 260, 280-Z	48-4500-WH	PART No.		
			2 Barrel universal	08-1013	● See Page 17 for details of Carb Mounting Plates.
			4 Barrel universal	08-1014	
			4 Barrel Holley Spreadbore	08-1024	

# VALVE COVERS

6=8

## CHROME PLATED STEEL VALVE COVERS & KITS

The CLIFFORD PERFORMANCE heavy gauge Chrome Steel Valve Cover is the latest look in 6 cylinder engine dress-up. It also accepts all emission control equipment. Covers come complete with gasket, rubber grommets & 3M cement.

MODEL	ENGINES	PART NO.
AMC/JEEP (1964-1980)	199, 232, 258 cu. in.	47-4075
CHEVY (1963 & later)	194, 230, 250*, 292 cu. in.	42-4075
FORD (1960 & later)	144, 170, 200, 250 cu. in.	43-4075
FORD (1965 & later)	240, 300 cu. in.	43-4095
MOPAR (1960-1980)	170, 198, 225 cu.in.	45-4075

\*Except engines equipped with cylinder heads with integral intake manifolds

## VALVE COVER HOLD-DOWN BREATHER KITS

Kit Contains: (qtys. vary with each engine model)

- one piece chrome T-handle hold-down bolts
- chrome hold-down tabs
- rectangular chrome push-in valve cover breather and grommet

MODEL	VALVE COVER P/N	KIT NO.
AMC/JEEP	47-4075 (ref)	47-4175
CHEVY	42-4075 (ref)	42-4175
FORD (sml. series)	43-4075 (ref)	43-4175
FORD (240,300)	43-4095 (ref)	43-4195
MOPAR	45-4075 (ref)	45-4175

## CHEVY SIDE COVERS

Chevy 6 cyl. heavy gauge chrome steel push rod side covers. These covers provide the finishing touches in straight 6 cyl. engine. Covers come complete with gaskets and chrome hold-down bolts.

CHEVY 194, 230 & 250 PART No. 42-2200

## CAST ALUMINUM COMPETION VALVE COVERS

- Rigid construction eliminates oil leak problems
- Black wrinkle finish for improved appearance
- Cast aluminum construction quiets rocker arm noise
- Area provided for PCV breather fitting
- Special finish virtually eliminates corrosion problems
- Enlarged inside dimensions allow clearance for roller rocker arms for racing
- Finned design helps maintain engine oil temperature

NOTE: All valve covers come complete with gasket, screws & 3M cement.

MODEL	VALVE COVER PART No.	REPLACEMENT GASKET PART No.
AMC/JEEP	199,232,258 cu.in. (1964-1986)	47-4050 (A) 67-5000
	258 cid. (1981-'86) stock repl. type	47-4060 67-5000
CHEVROLET	216,235,261 cu.in.(1937-59)	42-4000 (B) 62-5050
	194,230,250*, 292 cu. in.	42-4064* 62-5000
PONTIAC	215,230,250 cu. in. (OHV)	42-4064 62-5000
FORD	240,300 cu. in.	43-4176 63-5000
	144,170,200,250 cu. in.	43-4114 63-5050
MOPAR	170,198,225 cu. in. (1960-80)	45-4018 65-5000

\*Except engines equipped with cylinder heads with integral intake manifolds

These products are intended for racing purposes only. See back cover for other limitations.



42-4075

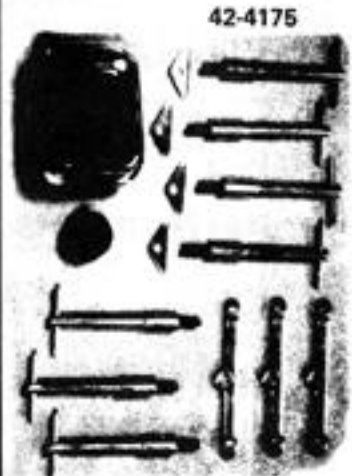

42-4175



47-4050

### Special NOTES:

for P/N 47-4050 & 47-4060

- (A) All 1981 thru 1986 AMC cylinder heads with plastic stock covers have no threaded holes to hold cover down, so it is required to drill and tap holes in head like early AMC heads have. Instructions included with covers.
- (B) Not our manufacture (comes polished only)

6=8

23

ALL CLIFFORD PERFORMANCE CAMSHAFTS ARE MANUFACTURED FROM NEW HIGH QUALITY BILLET CORES AND GROUND WITH THE LATEST COMPUTER PROFILES. DOMESTIC 4 & 6 CYLINDER ENGINES DIFFER FROM V8 ENGINES IN THAT THEY ARE USED IN A LOWER R.P.M. RANGE. THEREFORE, THE GRINDS LISTED IN THIS CATALOG HAVE BEEN DESIGNED TO MATCH THE AIR FLOW CHARACTERISTICS AND REQUIREMENTS OF YOUR 4 OR 6 CYLINDER ENGINE.

## GUIDE TO PROPER CAM SELECTION

### performance & economy

#### ● STAGE I TUNING

Best mileage will be attained by using a camshaft of 254° to 260° of duration. These camshafts will idle well and produce very smooth low R.P.M. torque. We always suggest using a hydraulic camshaft when possible in this type of application. Stick or automatic trannys OK.

#### ● STAGE II TUNING

- (a) The best overall combination of performance and mileage is produced by using a camshaft of 260° to 272° of duration. We recommend using exhaust headers and an improved intake system. Hydraulic grinds are best. Stick or automatic trannys as noted.
- (b) Camshafts 280° of duration and larger are considered high R.P.M. cams and require a correct combination of modifications to perform properly. Please contact our tech department for assistance before ordering. Stick shift tranny only.

#### ● STAGE III TUNING

### oval track

- (a) All 1/5, 1/4 and 3/8 mile short flat tracks with engines that have limited carburetion (i.e. 1, 2 or 4 barrel carburetion) and have less than 250 cid should use camshaft grinds of 270° - 280° or 280° - 290°. The larger engines of 290 cid and more can use grinds of 280° - 290° or 290° - 300° depending on track and carburetion used. Headers and head work a must.
- (b) All 1/2 to 5/8 mile large fast tracks with engine displacements of 250 or more can use 290° - 300° or 300° - 310° grinds. Carburetion of large 2 or 4 barrel or multi-carburetion is best. Headers and head work a must.

### drag racing

- (a) All limited carburetion engines with 2 or 4 barrel carbs should use moderate grinds of 290° to 310° duration. Automatic transmissions can be used ONLY if stall speed is increased to 2800-3000 rpm.
- (b) All unlimited carbureted engines with multi-carburetion (Webers, two 4 barrels, etc.) can use large cams. Most engines of 250 cid or more work best with 320° - 330° dual pattern grinds. Lighter chassis cars of 1500 lbs. or LESS can use 330° - 340° grinds. Headers and full head work a must.

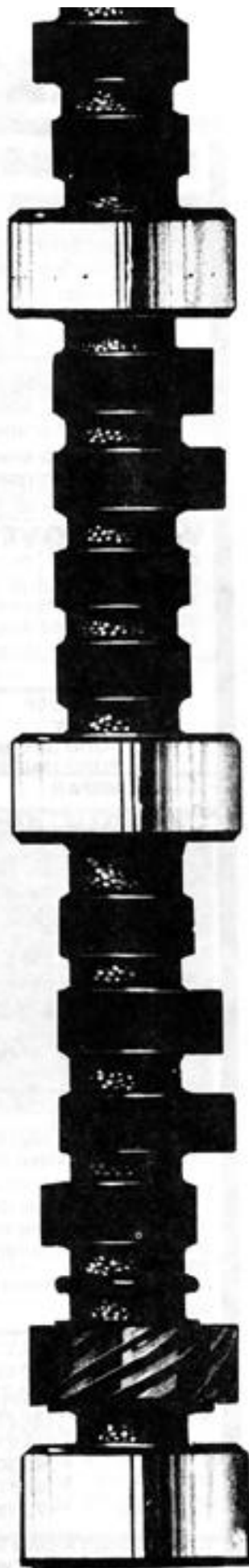



## • NOTE:

\*1/16" longer pushrods required  
on all grinds 270 or larger

## AMC-JEEP 199-232-258 cu. in. 6 CYL. (1965 & later)

### HYDRAULIC CAMS 150 cu. in. 4 CYL. (1984 & later)

GRIND No.	CAM PART NUMBER		VALVE LASH	Valve Lift w/1.5 ratio	Valve Lift w/1.6 ratio	DUR.	RPM Range	GENERAL CHARACTERISTICS
	4 cyl. (new)	6 cyl.						
254 H	97-3011	97-2011	.000	.432	.435	254°	1800 to 4000	High torque design. Ideal for R.V. and heavy duty truck applications. Works best with headers. Very smooth idle. Stick or auto.
264 H	97-3021	97-2021	.000	.444	.474	264°	2000 to 4500	Torque camshaft. Best choice for 4 wheel drive applications. Headers and 2 or 4 brl. recommended. Smooth idle. Stick or auto.
272 H	97-3041	97-2041*	.000	.449	.478	272°	2200 to 5000	Low and mid-range cam. For best results use a 2 or 4 barrel intake system and headers. Good idle. Stick only.
280 H	97-3081	97-2081*	.000	.467	.498	280°	2500 to 5500	Mid-range profile. Works well in high compression engines. 4 barrel and headers a must. Fair idle. Stick shift only.
290 H	97-3111	97-2111*	.000	.479	.510	290°	3000 to 6000	Mid-range and top end design. Recommended with standard transmission only. 4 barrel and headers a must. Rough idle. Stick only.

Part No. 4 cyl.	Part No. 6 cyl.	HYDRAULIC KIT ASSY'S
97-2991	97-2891	1972 & later W/1.6 ratio (stamped rocker)

(8) 97-1905	(12) 97-1901	HYDRAULIC TAPPETS
(8) 92-2912 (use stock)	(12) 91-2911	SPRINGS W/DAMPERS
	(12) 95-1941	SPRING RETAINERS
	(12) 97-2801	HD PUSHRODS
	(24) 97-1821	HD VALVE LOCKS

HYDRAULIC KIT ASSY. PART NO. 97-1981
1965 thru 1971 W/1.5 ratio (rockershaft) 6 CYL. ONLY

97-1901	(12) HYDRAULIC TAPPETS
91-2911	(12) SPRINGS W/DAMPERS
95-1941	(12) SPRING RETAINERS
97-1801	(12) HD PUSHRODS
97-1821	(24) HD VALVE LOCKS

## AMC-JEEP 199-232-258 cu. in. 6 Cylinder (1965 & later)

### MECHANICAL CAMS 150 cu.in. 4 CYL. (1984 & later)

GRIND No.	CAM PART NUMBER		VALVE LASH	Valve Lift w/1.5 ratio	Valve Lift w/1.6 ratio	DUR.	RPM Range	GENERAL CHARACTERISTICS
	4 cyl. (new)	6 cyl.						
(270 M)	97-3162	97-2162	(.020 in. .022 ex.)	(.490)	.523	270°	2200 to 5000	Low and mid-range cam. Works best when improved intake and exhaust system is used. Good idle.
280 M	97-3182	97-2182	.024 in. .026 ex.	.498	.531	280°	2500 to 5500	Strong mid-range design. Works well in automatic transmission cars. Improved intake system and headers recommended. Fair idle.
280 M 290	97-3192	97-2192 (new)	.024 in. .028 ex.	.498 in. .530 ex.	.531 in. .565 ex.	280° 290°	2500 to 6000	Short track cam. Designed to be used with our ram flow 2 or 4 barrel intake system. Rough idle.
290 M	97-3202	97-2202	.026 in. .028 ex.	.530	.565	290°	3000 to 6000	Short track cam designed to be used with limited carburetion. Rough idle.
290 M 300	97-3212	97-2212	.024 in. .026 ex.	.530 in. .515 ex.	.565 in. .549 ex.	290° in. 300° ex.	3000 to 6300	Short duration high lift profile. Works well in limited carburetion applications. Rough idle.
300 M	97-3222	97-2222	.028 in. .030 ex.	.558	.595	300°	3500 to 6500	Mid-range top end camshaft recommended on 3/8 to 1/2 mile tracks. Large carb and headers a must. Rough idle.
310 320 M	97-3252	97-2252 (new)	.028 in. .030 ex.	.569 in. .580 ex.	.606 in. .619 ex.	310° 320°	4000 to 7300	5/8 mile cam. Good equipment a must. Full carburetion recommended.

Part No. 4 cyl.	Part No. 6 cyl.	MECHANICAL KIT ASSY'S
97-2922	97-2982	1972 & later W/1.6 ratio (stamped rocker)

(8) 97-2905	(12) 97-1902	MECHANICAL TAPPETS
(8) 92-2912 (use stock)	(12) 92-3921	INNER & OUTER SPRINGS
	(12) 95-1941	SPRING RETAINERS
	(12) 97-2811	ADJUSTABLE PUSHRODS
	(24) 97-1821	HD VALVE LOCKS

MECHANICAL KIT ASSY. PART NO. 97-1982
1965 thru 1971 W/1.5 ratio (rockershaft) 6 CYL. ONLY

97-2902	(12) MECHANICAL TAPPETS
92-3921	(12) INNER & OUTER SPRINGS
95-1941	(12) SPRING RETAINERS
97-1811	(12) ADJUSTABLE PUSHRODS
97-1821	(24) HD VALVE LOCKS

• NOTE: Late (1972 and later) engines use a stamped steel, stud type rocker arm which is a 1.6 ratio. Early (1965 thru 1971) engines are equipped with a rockershaft type rocker arm assembly which is a 1.5 to 1 ratio.

PLEASE CHECK BEFORE ORDERING KIT ASSEMBLIES!

## CHEVROLET 194 - 230 - 250 cu. in. and 292 cu. in. HYDRAULIC CAMS 1.75 Rocker Ratio

GRIND No.	CAM PART NUMBER		VALVE LASH	VALVE LIFT	DUR.	RPM Range	GENERAL CHARACTERISTICS
	194 thru 250	292 cu in					
254 H	92-3011	92-4011	.000	.476	254°	1800 to 4000	Low RPM torque cam designed to suit today's low compression engines. Improves throttle response and acceleration. Very smooth idle.
264 H	92-3021	92-4021	.000	.518	264°	2000 to 4500	High torque design. Ideal for R-V applications. Works best with headers. Smooth idle. Stick or auto OK.
270 H	92-3041	92-4041	.000	.524	270°	2200 to 5000	Strong mid-range camshaft. Works best with ramflow 2 or 4 barrel intake system and headers. Fair idle. Stick only.
280 H	92-3081	92-4081	.000	.544	280°	2500 to 5500	Mid-range, top end design. 4 barrel ram flow intake and headers recommended. Rough idle. Stick only.
290 H	92-3091	92-4091	.000	.558	290°	3000 to 6000	Mid-range, top end design. 4 barrel ram flow intake and headers recommended. Rough idle. Stick only.

### HYDRAULIC KIT ASSEMBLY 194-230-250 cu. in. PART No. 92-3981

92-3901 12 HYDRAULIC TAPPETS  
92-3912 12 CHROME-SILICON SPRINGS  
92-3942 12 SPRING RETAINERS (steel)  
92-1821 24 HEAVY DUTY VALVE LOCKS  
92-3801 12 CHROME-MOLY PUSHRODS

### HYDRAULIC KIT ASSEMBLY 292 cu. in. PART No. 92-4981

92-3901 12 HYDRAULIC TAPPETS  
92-3912 12 CHROME-SILICON SPRINGS  
92-3942 12 SPRING RETAINERS (steel)  
92-1821 24 HEAVY DUTY VALVE LOCKS  
92-4801 12 CHROME-MOLY PUSHRODS

• NOTE: The valve springs in this kit have been designed to install without machine work

## CHEVROLET 194 - 230 - 250 cu. in. and 292 cu. in. MECHANICAL CAMS 1.75 Rocker Ratio

GRIND No.	CAM PART NUMBER		VALVE LASH	VALVE LIFT	DUR.	RPM Range	GENERAL CHARACTERISTICS
	194 thru 250	292 cu in					
270 M	92-3162	92-4162	.020 in. .022 ex.	.573	270°	2200 to 5000	Low and mid-range cam. Works best when improved intake system is used. Headers a must. Good idle.
280 M	92-3182	92-4182	.024 in. .026 ex.	.581	280°	2500 to 5500	Strong mid-range cam. Improved intake and exhaust recommended. Fair idle.
280/290 M	92-3192	92-4192	.024 in. .028 ex.	.581 in. .618 ex.	280° in. 290° ex.	2500 to 5800	Short track cam. Designed to be used with our ram flow 2 or 4 barrel intake system. Rough idle.
290 M	92-3202	92-4202	.026 in. .028 ex.	.618	290°	3000 to 6000	Short track cam designed to be used with limited carburetion. Rough idle.
302 M	92-3222	92-4222	.028 in. .030 ex.	.651	302°	3500 to 6500	1/2 mile cam. Designed to be used with ram flow 2 or 4 barrel intake and headers.
302/310 M	92-3232	92-4232	.028 in. .030 ex.	.651 in. .635 ex.	302° in. 310° ex.	3500 to 6800	5/8 mile cam. Works best with 4 barrel carb or Weber assembly. Headers a must.
310/320 M	92-3252	92-4252	.028 in. .030 ex.	.633 in. .647 ex.	310° in. 320° ex.	4000 to 7000	Top end profile intended for use in drag race applications.

### MECHANICAL KIT ASSEMBLY 194-230-250 cu. in. PART No. 92-3982

92-3902 12 MECHANICAL TAPPETS  
92-3921 12 INNER & OUTER SPRINGS  
92-3941 12 SPRING RETAINERS (alum.)  
92-1821 24 HEAVY DUTY VALVE LOCKS  
92-3801 12 CHROME-MOLY PUSHRODS

### MECHANICAL KIT ASSEMBLY 292 cu. in. PART No. 92-4982

92-3902 12 MECHANICAL TAPPETS  
92-3921 12 INNER & OUTER SPRINGS  
92-3941 12 SPRING RETAINERS (alum.)  
92-1821 24 HEAVY DUTY VALVE LOCKS  
92-4801 12 CHROME-MOLY PUSHRODS

• NOTE: The valve springs in this kit require machine work for installation

**4 cyl. CHEVROLET 153 and 181 cu. in** (Also Pre 1978  
151 cu. in. Non-Crossflow)  
**AMC & GM Iron Duke 151 cu. in** 1978 & Later Crossflow Head

**HYDRAULIC CAMS 1.75 Rocker Ratio**

GRIND No.	CAM PART NUMBER		VALVE LASH	VALVE LIFT	DUR.	RPM Range	GENERAL CHARACTERISTICS
	153 & 181 cu in	IRON DUKE 151 cu in					
254 H	92-2011	92-0011	.000	.476	254°	1800 to 4500	Torque cam. Produces more torque than stock cam and power range 1500 RPM longer than stock. Very smooth idle. Stick or auto OK.
264 H	92-2021	92-0021	.000	.518	264°	2000 to 5000	High torque design. Ideal for RV and marine application. Works best with headers. Smooth idle. Stick or auto OK.
270 H	92-2041	92-0041	.000	.524	270°	2200 to 5500	Mid range cam. Works best with 2 or 4 barrel carb and headers. Ideal for street rod applications. Fair idle. Stick only.
280 H	92-2081	92-0081	.000	.544	280°	2500 to 6000	Mid-range and top end camshaft. Headers and large carb a must. Rough idle. Stick only.

HYDRAULIC KIT ASSEMBLY (EXCEPT IRON DUKE) PART No. 92-2981

Hydraulic Kit Assembly IRON DUKE KIT only PART No. 92-2983

92-2901 8 HYDRAULIC TAPPETS  
92-2942 8 SPRING RETAINERS (steel)  
92-2912 8 CHROME-SILICON SPRINGS  
92-2821 16 HEAVY DUTY VALVE LOCKS  
92-2801 8 CHROME-MOLY PUSHRODS

(new) 96-2901 8 HYDRAULIC TAPPETS  
92-2942 8 SPRING RETAINERS (steel)  
92-2912 8 CHROME-SILICON SPRINGS  
92-2821 16 HEAVY DUTY VALVE LOCKS

• NOTE: The valve springs in this kit have been designed to install without machine work.

**4 cyl. CHEVROLET 153 and 181 cu. in** (Also Pre 1978  
151 cu. in. Non-Crossflow)  
**AMC & GM Iron Duke 151 cu. in** 1978 & Later Crossflow Head

**MECHANICAL CAMS 1.75 Rocker Ratio**

GRIND No.	CAM PART NUMBER		VALVE LASH	VALVE LIFT	DUR.	RPM Range	GENERAL CHARACTERISTICS
	153 & 181 cu in	IRON DUKE 151 cu in					
270 M	92-2162	92-0162	.020/.022	.573	270°	2200 to 5500	Mid-range profile. Works well in street rod applications. 2 or 4 barrel carb recommended. Fair idle. Stick only.
280 M	92-2182	92-0182	.024/.026	.581	280°	2500 to 6000	Mid-range top end cam. Headers and large carb a must. Rough idle. Stick only.
290 M	92-2202	92-0202	.026/.028	.618	290°	3000 to 6500	3/8 mile design. Ideal for limited carburetor applications. Rough idle.
302 M	92-2222	92-0222	.028/.030	.651	302°	3500 to 7000	Short duration high lift design. Excellent 1/2 mile camshaft. Must use headers and large carburetor. Rough idle.
310 M	92-2242	92-0242	.028/.030	.663	310°	4000 to 7500	Short duration high lift cam designed to be used in various high RPM applications. Rough idle.

MECHANICAL KIT ASSEMBLY (EXCEPT IRON DUKE) PART No. 92-2982

Mechanical Kit Assembly IRON DUKE KIT only PART No. 92-2984

92-2902 8 MECHANICAL TAPPETS  
92-2921 8 INNER & OUTER SPRINGS  
93-3942 8 SPRING RETAINERS (alum.)  
92-2821 16 HEAVY DUTY VALVE LOCKS  
92-2801 8 CHROME-MOLY PUSHRODS

91-3902 8 MECHANICAL TAPPETS  
92-2921 8 INNER & OUTER SPRINGS  
93-3942 8 SPRING RETAINERS (alum.)  
92-2821 16 HEAVY DUTY VALVE LOCKS

• NOTE: The valve springs in this kit require machine work for installation.

## CHEVROLET 235 and 261 cu. in. 1954 thru 1962 HYDRAULIC CAMS 1.50 Rocker Ratio

GRIND No.	1954 & later LARGE BEARING PART No.	Pre-1954 SMALL BEARING * PART No.	VALVE LASH	VALVE LIFT	DUR.	RPM Range	GENERAL CHARACTERISTICS
256 H	92-1011	92-7011	.000	.408	256°	1800 to 3800	Low RPM torque cam designed to a 10% increase in power output of a stock engine. Very smooth idle. Stick or auto.
264 H	92-1021	92-7021	.000	.444	264°	2000 to 4200	High torque camshaft. Headers and additional carburetion recommended. Smooth idle. Stick or auto.
272 H	92-1061	92-7061	.000	.449	272°	2200 to 4800	Strong mid-range cam. Works best with ram flow 2 or 4 barrel intake system and headers. Good idle. Stick only.

### HYDRAULIC KIT ASSEMBLY PART No. 92-1981

92-1901	12 HYDRAULIC TAPPETS
92-1921	12 INNER & OUTER SPRINGS
92-1941	12 SPRING RETAINERS
92-1821	24 HEAVY DUTY VALVE LOCKS
92-1801	12 CHROMOLY PUSH RODS

- NOTE: *The valve springs in this kit have been designed to install without machine work.*

\*SMALL CAM BEARING SIZE IS 2.030 measured at no. 1 bearing.



## CHEVROLET 235 and 261 cu. in. 1954 thru 1962 MECHANICAL CAMS 1.50 Rocker Ratio

GRIND No.	1954 & later LARGE BEARING PART No.	Pre-1954 SMALL BEARING * PART No.	VALVE LASH	VALVE LIFT	DUR.	RPM Range	GENERAL CHARACTERISTICS
260 M	92-1132	92-7132	.016 in. .018 ex.	.428	260°	2000 to 4200	Produces more torque and overall power than stock camshaft without additional fuel consumption. Very smooth idle.
270 M	92-1152	92-7152	.020 in. .022 ex.	.490	270°	2200 to 4800	Mid-range design. Ram flow 2 or 4 barrel intake system and headers recommended. Good idle.
280/290 M	92-1192	—	.024 in. .026 ex.	.498 in. .529 ex.	280° in. 290° ex.	2500 to 5200	Mid-range camshaft recommended for short track applications where limited carburetion must be used.
290/300 M	92-1212	—	.024 in. .026 ex.	.530 in. .515 ex.	290° in. 300° ex.	3000 to 5500	Mid-range and top end cam designed for the well set-up 3/8 and 1/2 mile cars. Good equipment a must.
300/310 M	92-1232	—	.028 in. .030 ex.	.558 in. .544 ex.	300° in. 310° ex.	3000 to 6000	Top end cam designed for 5/8 mile oval and drag race applications. 4 barrel carb a must.

### MECHANICAL KIT ASSEMBLY PART No. 92-1982

92-1902	12 MECHANICAL TAPPETS
92-1921	12 INNER & OUTER SPRINGS
92-1941	12 SPRING RETAINERS
92-1821	12 HEAVY DUTY VALVE LOCKS
92-1801	12 CHROMOLY PUSH RODS

- NOTE: *The valve springs in this kit have been designed to install without machine work.*

\*SMALL CAM BEARING SIZE IS 2.030

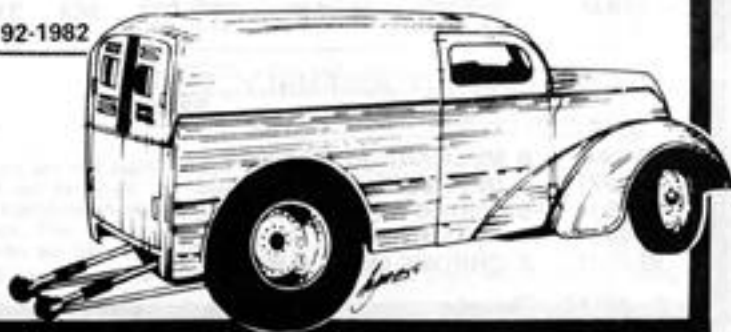

## FORD 240 and 300 cu. in. HYDRAULIC CAMS 1.60 Rocker Ratio

GRIND No.	PART No.	VALVE LASH	VALVE LIFT	DUR.	RPM Range	GENERAL CHARACTERISTICS
264 H	93-3021	.000	.474	264°	2000 to 4500	High torque design. Ideal for R.V. and heavy duty truck applications. Works best with headers. Very smooth idle. Auto or stick.
270 H	93-3031	.000	.478	270°	2200 to 5000	Low and mid-range cam. For best results use a ram flow 2 or 4 barrel intake system and headers a must. Good idle. Auto or stick.
280 H	93-3081	.000	.498	280°	2500 to 5500	Mid-range profile. Works well in high compression engines. 4 barrel and headers a must. Fair idle. Stick only.
290 H	93-3111	.000	.510	290°	3000 to 6000	Mid-range and top end design. Recommended with standard transmission only. 4 barrel and headers a must. Rough idle.

### HYDRAULIC KIT ASSEMBLY PART No. 93-3981

93-3901	12 HYDRAULIC TAPPETS
91-2911	12 CHROME-SILICON SPRINGS
92-3941	12 SPRING RETAINERS*
92-1821	24 HEAVY DUTY VALVE LOCKS
93-3801	12 CHROMOLY PUSHRODS

\*NOTE: 1979 & later heads with exhaust valve "ROTORS" will need different spring retainers to keep the minimum installed spring height of 1.700".



## FORD 240 and 300 cu. in. MECHANICAL CAMS 1.60 Rocker Ratio

GRIND No.	PART No.	VALVE LASH	VALVE LIFT	DUR.	RPM Range	GENERAL CHARACTERISTICS
270 M	93-3162	.020/.022	.532	270°	2200 to 5000	Low and mid-range cam. Works best when improved intake and exhaust system is used. Good idle. Stick only.
280 M	93-3182	.024/.026	.531	280°	2500 to 5500	Strong mid-range design. Improved intake system and headers recommended. Fair idle. Stick only.
280/290 M	93-3192	.024/.026	.531 in. .565 ex.	280° in. 290° ex.	2500 to 5800	Short track cam. Designed to be used with our ram flow 2 or 4 barrel intake system. Rough idle.
290 M	93-3202	.026/.028	.565	290°	3000 to 6000	Short duration high lift profile. Works well in limited carburetion applications. Rough idle.
290/300 M	93-3212	.024/.026	.565 in. .549 ex.	290° in. 300° ex.	3000 to 6300	Mid-range top end camshaft recommended on 3/8 to 1/2 mile tracks. Large carb and headers a must. Rough idle.
300 M	93-3222	.028/.030	.595	300°	3500 to 6500	Mid-range top end cam. Used on 3/8 and 1/2 mile track with unlimited carburetion. Headers a must.
310 M	93-3232	.028/.030	.606	310°	4000 to 6800	5/8 mile cam. Good equipment a must. Full carburetion recommended.
320 M	93-3252	.028/.030	.619	320°	4500 to 7000	High RPM drag race camshaft. Good equipment a must. Full carburetion recommended.

### MECHANICAL KIT ASSEMBLY PART No. 93-3982

93-3902	12 MECHANICAL TAPPETS
92-3921	12 INNER & OUTER SPRINGS
92-3941	12 SPRING RETAINERS
92-1821	24 HEAVY DUTY VALVE LOCKS
93-3801	12 CHROMOLY PUSH RODS



These products are intended for racing purposes only. See back cover for other limitations.

**FORD 170 - 200 - 250 cu. in.****HYDRAULIC CAMS 1.50 Rocker Ratio**

GRIND No.	PART No.	VALVE LASH	VALVE LIFT	DUR.	RPM Range	GENERAL CHARACTERISTICS
254 H	93-2011	.000	.408	254°	1800 to 4200	Low RPM torque cam designed to suit today's low compression engines. Improves throttle response and acceleration. Very smooth idle.
264 H	93-2021	.000	.444	264°	2000 to 4500	High torque cam design. Ideal for RV and towing applications. Headers recommended. Very smooth idle. Stick or auto OK.
272 H	93-2061	.000	.449	272°	2200 to 5000	Strong mid-range camshaft. Works best with 2 or 4 barrel carb and headers. Good idle. Stick only.
280 H	93-2081	.000	.467	280°	2500 to 5500	Mid-range and top end profile. Works best in high compression engines. Improved intake and exhaust recommended. Rough idle.

**HYDRAULIC KIT ASSEMBLY PART No. 93-2981**

93-2901	12 HYDRAULIC TAPPETS
92-1921	12 INNER & OUTER SPRINGS
93-2941	12 SPRING RETAINERS
93-2821	24 HEAVY DUTY VALVE LOCKS

**FORD 144 - 170 - 200 - 250 cu. in.****MECHANICAL CAMS (SEE NOTE BELOW)  
1.50 Rocker Ratio**

GRIND No.	PART No.	VALVE LASH	VALVE LIFT	DUR.	RPM Range	GENERAL CHARACTERISTICS
260 M	93-2132	.016 in. .018 ex.	.428	260°	2000 to 4300	Low RPM torque camshaft designed to be used in RV applications. Broad power range. Very smooth idle. Stick or auto OK.
270 M	93-2152	.016 in. .018 ex.	.447	270°	2200 to 5000	Low and mid-range design. Works best with improved intake and exhaust system. Smooth idle. Stick only.
280 M	93-2182	.016 in. .018 ex.	.464	280°	2500 to 5500	Strong mid-range cam. Works best in standard transmission car. Good idle. Extra carburetion recommended.
280/290 M	93-2192	.024 in. .026 ex.	.498 in. .530 ex.	280° in. 290° ex.	2500 to 5800	Short track cam. Designed to be used with limited carburetion. Fair idle.
290 M	93-2202	.026 in. .028 ex.	.530	290°	3000 to 6000	Mid-range design. Ideal for 3/8 mile cars. Improved intake and exhaust recommended. Rough idle.
300 M	93-2222	.028 in. .030 ex.	.558	300°	3500 to 6500	Drag race and 1/2 mile cam. Headers and large carb a must. Rough idle.
310 M	93-2252	.028 in. .030 ex.	.569	310°	4000 to 7000	Drag race only cam. Must have all the best parts to work. Full carburetion recommended.

**MECHANICAL KIT ASSEMBLY PART No. 93-2982**

93-2902	12 MECHANICAL TAPPETS
92-1921	12 INNER & OUTER SPRINGS
93-2941	12 SPRING RETAINERS
93-2821	24 HEAVY DUTY VALVE LOCKS

• NOTE: If your engine is equipped with a non-adjustable rocker arm assembly, it will be necessary to purchase a set of adjustable rocker arms from 1964 engine and use below push rods.

93-3810 (new)	Adjustable Rocker Arm Assy. (remanufactured)
932801	12 PUSH RODS (144 thru 200 cu. in.)
932802	12 PUSH RODS (250 cu. in.)

# CAMSHAFTS

## FORD 223 cu. in 1954 thru 1964 MECHANICAL CAMS — Regrinds Only

1.40  
Rocker Ratio

GRIND No.		VALVE LASH	VALVE LIFT	DUR.	RPM Range	GENERAL CHARACTERISTICS
260 M	93-1132	.016/.018	.399	260°	1800 to 4400	Hi torque camshaft. The best choice when brute muscle is required. Headers recommended. Smooth idle. Stick or auto OK.
270 M	93-1152	.020/.022	.458	270°	2200 to 5000	Mid-range design. Ram flow 2 or 4 barrel intake system and headers recommended. Good idle. Stick only.

USED CORE DEPOSIT — PART No. 93-0000

• NOTE: All cams are on an exchange basis. If no core is sent, then add for core charge.

### MECHANICAL KIT ASSEMBLY PART No. 93-1982

93-1902 12 MECHANICAL TAPPETS  
91-2911 12 SPRINGS  
93-1801 12 CHROMOLY PUSH RODS

92-3941 12 SPRING RETAINERS  
92-1821 24 HEAVY DUTY VALVE LOCKS

NOTE: The valve springs in this kit have been designed to install without machine work.

## FORD 2000 cc 1971 thru 1975 S.O.H.C. MECHANICAL CAMS

CAPRI, PINTO & MUSTANG 1.60  
Rocker Ratio

GRIND No.	PART No.	VALVE LASH	VALVE LIFT	DUR.	RPM Range	GENERAL CHARACTERISTICS
272 O.H.C.	93-4152	.008/.010	.436	274°	2200 to 5500	Broad power range camshaft. Works well in stock engine equipped with headers. Good idle. Excellent street cam stick or automatic.
280 O.H.C.	93-4182	.006/.008	.470	280°	2500 to 6000	Broad power range, street or competition. Stick shift only with lower gears. Likes headers & good carburetion. Fair idle.
292 O.H.C.	93-4192	.006/.008	.545	292°	3000 to 6500	Mid range & top end. Stick shift only. Hot street, drags, slaloms, etc. Needs higher compression headers & good carburetion. Rough idle.
308 O.H.C.	93-4212	.012/.014	.560	308°	3500 to 7000	Strictly top end competition cam. R.P.M. must be kept up at all times. Must have higher compression, headers & full carburetion.

### MECHANICAL KIT ASSEMBLY PART No. 93-4982

93-2921 8 INNER & OUTER SPRINGS  
93-3952 8 SPRING RETAINERS  
93-4001 8 CAM FOLLOWERS/ROCKERS

• NOTE: The valve springs in this kit have been designed to install without machine work. All valve guides should be shortened for all cam grinds.

## FORD 2300 cc 1974 thru 1984 S.O.H.C.

### HYDRAULIC CAMS CAPRI, PINTO, MUSTANG & RANGER 1.65 Rocker Ratio

GRIND No.	PART No.	VALVE LASH	VALVE LIFT	DUR.	RPM Range	GENERAL CHARACTERISTICS
274 O.H.C.	93-5152	.000	.436	274°	2200 to 5500	Broad power range. Works well in stock engine equipped with headers. Good idle. Excellent street cam. Stick or automatic.
280 O.H.C.	93-5182	.000	.475	280°	2500 to 6000	Broad power range, street or competition. Stick shift only with lower gears. Likes headers & good carburetion. Fair idle.
292 O.H.C.	93-5192	.000	.485	292°	3000 to 6500	Mid range & top end. Stick shift only. Hot street, drags, slaloms, etc. Needs higher compression, headers & good carburetion. Rough idle.

### HYDRAULIC KIT ASSEMBLY PART No. 93-5981

93-2931 8 INNER & OUTER SPRINGS  
93-3962 8 SPRING RETAINERS  
93-4010 8 CAM FOLLOWERS/ROCKERS

• NOTE: The valve springs in this kit require machine work for installation. All valve guides should be shortened for all cam grinds.

## MOPAR 170 - 198 - 225 cu. in. 1960 thru 1981

### MECHANICAL CAMS with Adjustable Rocker Arms only 1.50 Rocker Ratio

GRIND No.	PART No.	VALVE LASH	VALVE LIFT	DUR.	RPM Range	GENERAL CHARACTERISTICS
260 M	95-1132	.016 in. .018 ex.	.428	260°	2000 to 4500	Low RPM torque cam improves throttle response and acceleration. Very smooth idle. Stick or auto OK.
268 M	95-1152	.016 in. .018 ex.	.447	268°	2200 to 5000	High torque design. Ideal for RV applications. Works best with headers. Smooth idle. Stick only.
276 M	95-1182	.016 in. .018 ex.	.464	276°	2400 to 5300	Strong mid-range cam. Improved intake and exhaust recommended. Fair idle. Stick only.
280/290 M	95-1192	.024 in. .026 ex.	.498 in. .530 ex.	280° in. 290° ex.	2500 to 5500	Short track cam designed to be used with limited carburetion. Rough idle. Stick only.
290 M	95-1202	.026 in. .028 ex.	.530	290°	3000 to 5800	Short track cam. Works best with ram flow intake system and headers. Rough idle.
290/300 M	95-1212	.026 in. .028 ex.	.530 in. .515 ex.	290° in. 300° ex.	3000 to 6000	1/2 mile camshaft. Designed to be used with 4 barrel ram flow intake system and headers. Rough idle.
300 M	95-1222	.028 in. .030 ex.	.558	300°	3500 to 6300	1/2 and 5/8 mile design. Works best with 4 barrel carb or Weber side draught assembly.
310 M	95-1252	.028 in. .030 ex.	.569	310°	4000 to 6800	Top end camshaft intended for drag race applications. Large carburetor and headers a must. Rough idle.
320 M	95-1272	.028 in. .030 ex.	.580	320°	4500 to 7000	Drag race cam only. Works best with Weber side draught intake assembly.



• SEE NOTES  
BELOW

### MECHANICAL KIT ASSEMBLY PART No. 95-1982

95-1902	12 MECHANICAL TAPPETS
92-1921	12 INNER & OUTER SPRINGS
95-1941	12 SPRING RETAINERS

## MOPAR 198 - 225 cu. in. 1981 & later

### HYDRAULIC CAMS 1.50 Rocker Ratio

GRIND No.	PART No.	VALVE LASH	VALVE LIFT	DUR.	RPM Range	GENERAL CHARACTERISTICS
254 H	95-2011	.000	.408	254°	1800 to 4200	Low RPM torque cam improves throttle response and acceleration. Very smooth idle. Stick or auto.
264 H	95-2021	.000	.444	264°	2000 to 4500	High torque cam design. Ideal for RV and towing applications. Headers recommended. Very smooth idle. Stick or auto OK.
272 H	95-2061	.000	.449	272°	2200 to 5000	Strong mid-range camshaft. Works best with 2 or 4 barrel carb and headers. Good idle. Stick only.
280 H	95-2081	.000	.467	280°	2500 to 5500	Mid-range and top end profile. Works best in high compression engines. Improved intake and exhaust recommended. Rough idle.

### HYDRAULIC KIT ASSEMBLY PART No. 95-1981

95-1901	12 HYDRAULIC TAPPETS
92-1921	12 INNER & OUTER SPRINGS
95-1941	12 SPRING RETAINERS

• NOTES: ( Applies to Hydraulic & Mechanical cams )

1. See Page 35 for Chromoly Push Rods & Valve Locks
2. The valve springs in these kits require machine work for installation.



## DATSUN 4 cyl. 1600, 1800, 2000 cc S.O.H.C. DATSUN 6 cyl. 240-Z, 260-Z, 280-Z S.O.H.C.

### MECHANICAL CAMS 1.50 Rocker Ratio

GRIND No.	4 cyl. PART No.	240-Z & 260-Z 6 cyl. PART No.	280-Z 6 cyl. PART No.	VALVE LASH	VALVE LIFT	DUR.	RPM Range	GENERAL CHARACTERISTICS
268 O.H.C.	98-1152	98-2152	98-4152	.008 in. .010 ex.	.450	268°	2000 to 5500	High torque design. Ideal for O.R.V. applications. Works best with exhaust headers. Smooth idle. Stick or auto OK.
278 O.H.C.	98-1182*	98-2182*	98-4182	.008 in. .010 ex.	.495	278°	2300 to 6000	Broad power range camshaft. Works well in stock engine equipped with headers. Good idle. Stick only.
288 O.H.C.	98-1202*	98-2202*	98-4202	.008 in. .010 ex.	.510	288°	2700 to 6500	Mid-range design. Ideal for slalom events. Increases R.P.M. potential greatly. Fair idle. Stick only.
298 O.H.C.	98-1222*	98-2222*	98-4222	.008 in. .010 ex.	.510	298°	3500 to 7000	High R.P.M. camshaft. Works best in well prepared high R.P.M. engine assembly. Rough idle. Stick only.

#### 4 cyl. PART No. 98-1982 MECHANICAL KIT ASSEMBLY

98-1921	8 INNER & OUTER SPRINGS
98-1941	8 ANODIZED SPRING RETAINERS
98-2984	8 LASH PADS (.170")

#### 6 cyl. PART No. 98-2982 MECHANICAL KIT ASSEMBLY

98-2921	12 INNER & OUTER SPRINGS
98-2941	12 ANODIZED SPRING RETAINERS
98-2986	12 LASH PADS (.170")

\*Corrective lash pads required

- NOTE: The valve springs in these kits have been designed to install without machine work. All valve guides should be shortened for all cam grinds.

Components may also be ordered separately

## TOYOTA 4 cyl. 20 and 22R S.O.H.C.

### MECHANICAL CAMS \* 1.45 Rocker Ratio

GRIND No.	PART No.	VALVE LASH	VALVE LIFT	DUR.	RPM Range	GENERAL CHARACTERISTICS
256 O.H.C.	98-3122	.008 in. .010 ex.	.420	256°	1800 to 5000	Torque & mileage cam. Produces more torque than stock cam at 2500 RPM and power range 1500 RPM higher than stock. Very smooth idle. Stock valve springs are OK.
270 O.H.C.	98-3152	.008 in. .010 ex.	.435	270°	2200 to 5500	Broad power range. Works well in stock engine equipped with headers. Good idle.
282 O.H.C.	98-3182	.008 in. .010 ex.	.480	282°	2500 to 6000	Mid-range design. Ideal for slalom events. Fair idle.
294 O.H.C.	98-3202	.008 in. .010 ex.	.495	294°	3000 to 6500	High RPM camshaft. Works best in well prepared high RPM engine assembly. Rough idle.

#### MECHANICAL KIT ASSEMBLY

93-2921	8 INNER & OUTER VALVE SPRINGS
---------	-------------------------------

- NOTE: Use stock spring retainers

Components may also be ordered separately

\*TECH NOTE: A 4° to 6° advance on cam works best with these cams.

#### NOTE:

The valve springs in this kit have been designed to install without machine work, but new cam followers should be used. See local Toyota dealer for these cam followers.

All valve guides should be shortened for all cam grinds.

## TOYOTA LANDCRUISER 6cyl. 1968 & LATER

1.5 Rocker Ratio

GRIND No.		VALVE LASH	VALVE LIFT	DUR.	RPM Range	GENERAL CHARACTERISTICS
260 M	98-5132	.016 in. .018 ex.	.428	260°	1800 to 4400	Hi torque camshaft. The best choice when brute muscle is required. Headers recommended. Smooth idle. Stick or auto OK.
270 M	98-5152	.020 in. .022 ex.	.447	270°	2200 to 5000	Mid-range design. Ram flow 2 or 4 barrel intake system and headers recommended. Good idle. Stick only.

## PONTIAC 230-250 1966-70 HYDRAULIC O.H.C.

1.5 R.Ratio

GRIND No.	PART No.	VALVE LASH	VALVE LIFT	DUR.	RPM Range	GENERAL CHARACTERISTICS
270 O.H.C.	96-5152 (New Billet)	.000	.450	270°	2200 to 5500	Broad power range camshaft. Works well in stock engine equipped with headers. Good idle. Excellent street cam stick or automatic.
280 O.H.C.	96-5152 (Regrinds Only)	.000	.465	280°	2500 to 6000	Broad power range, street or competition. Stick shift only with lower gears. Likes headers & good carburetion. Fair idle.
300 O.H.C.	96-5202 (Regrinds Only)	.000	.490	300°	3000 to 6500	Mid range & top end. Stick shift only. Hot street, drags, slaloms, etc. Needs higher compression headers & good carburetion. Rough idle.

12 Cam followers Part No. 96-1262  
12 Hydraulic tappets Part No. 96-1353

12 pr. H.D. valve locks Part No. 92-1821  
12 Valve springs (inner & outer) Part No. 92-1921

## HEAVY DUTY VALVE LOCKS

These H.D. valve locks are made from hi-quality steel and heat treated for extra strength and are 3 times stronger than O.E.M. (factory) valve locks. Highly recommended for moderate and full competition applications.

DESCRIPTION	QUANTITY	PART No.
5/16 (8mm) sgl. groove	8pr (16)	97-1822 (new)
5/16 single groove	12pr (24)	93-2821
11/32 single groove	8pr (16)	92-2821
11/32 single groove	12pr (24)	92-1821
3/8 single groove	12pr (24)	97-1821
3/8 2 groove	6pr (12)	95-1821
3/8 4 groove	12pr (24)	95-2821



## CHROME-MOLY PUSHRODS

Clifford Performance Pushrods are manufactured from the finest material available. This prevents excessive wear and insures long life. Designed to replace the stock pushrod without modification to any engine component.

	PART No.
AMC 199,232,258 (Pre'72)	97-1801
AMC (Pre'72) adjustable	97-1811
AMC 199,232,258 (72'up)	97-2801*
AMC (72 & up) adjustable	97-2811
AMC 150 cu. in. (1985 up)	97-2802
CHEV 235 and 261 cu. in.	92-1801
CHEV 153 and 181 cu. in.	92-2801
CHEV 194,230,250 cu. in.	92-3801
CHEV 292 cu. in.	92-4801
CHEV 173 cu. in. V-6	92-3945
CHEV 200,229 cu. in. V-6	92-5801
FORD 223 and 262 cu. in.	93-1801
FORD 240 and 300 cu. in.	93-3801
FORD w/adj. rocker arm 250 cu. in.	93-2802
FORD w/adj. rocker arm 144 and 200 cu. in.	93-2801
MOPAR 170 cu. in.	95-1801
MOPAR 198 and 225 cu. in.	95-1802**

\*1/16 longer than stock length



(\*\* Pre-1981 Mechanical Cams)

## ALUMINUM-BRONZE GEARS

Sustained high RPM and load can cause premature distributor gear failure. The solution to this problem is an aluminum bronze gear. The Clifford gear is compatible with all cast iron and steel billet camshafts.

		PART No.					
AMC	150, 199, 232, 242, 258 cu. in.	97-3862					
AMC/GM	151 cu. in. (4 cyl.)	92-3862					
CHEVROLET & GMC	<table border="0"> <tr> <td rowspan="4" style="font-size: 3em; vertical-align: middle;">}</td> <td>235, 261 cu. in.</td> <td rowspan="4" style="vertical-align: middle;">92-3862</td> </tr> <tr> <td>153, 181 cu. in. (4 cyl.)</td> </tr> <tr> <td>194, 230, 250, 292 cu. in.</td> </tr> <tr> <td>228, 248, 270, 302</td> </tr> </table>	}	235, 261 cu. in.	92-3862	153, 181 cu. in. (4 cyl.)	194, 230, 250, 292 cu. in.	228, 248, 270, 302
}	235, 261 cu. in.		92-3862				
	153, 181 cu. in. (4 cyl.)						
	194, 230, 250, 292 cu. in.						
	228, 248, 270, 302						
FORD	240, 300 cu. in.	93-3862					

## TIMING SETS

Clifford Timing Sets are engineered to withstand extreme high loads and are packaged as matched sets thus eliminating noisy operation. Instruction sheets are furnished with each set.

		PART No.						
GMC	248, 270, 302 cu. in.	92-3871						
CHEVROLET	<table border="0"> <tr> <td rowspan="2" style="font-size: 3em; vertical-align: middle;">}</td> <td>235 and 261 cu. in.</td> <td rowspan="2" style="vertical-align: middle;">92-3871</td> </tr> <tr> <td>194 thru 292 cu. in.</td> </tr> <tr> <td></td> <td>153 and 181 cu. in.</td> <td></td> </tr> </table>	}	235 and 261 cu. in.	92-3871	194 thru 292 cu. in.		153 and 181 cu. in.	
}	235 and 261 cu. in.		92-3871					
	194 thru 292 cu. in.							
	153 and 181 cu. in.							
FORD	144 thru 200 cu. in.	93-2871						
FORD	240 and 300 cu. in.	93-3871						
FORD	223 and 262 cu. in.	93-1871*						
MOPAR	170 thru 225 cu. in.	95-1871						
MOPAR	170 thru 225 cu. in.	95-1972* (new)						
AMC / JEEP	199, 232, 258 cu. in.	97-1871						
AMC / JEEP	199, 232, 258 cu. in.	97-1972*						
AMC / GM	151 cu. in.	92-3871						

- NOTE: Part No.'s 92-3871, 93-3871 & 97-1972 all have 3 key ways in crank sprocket or gear for easy advance or retarding cam.

\* Double Roller Series. A MUST for race car use.

## TIMING COVERS

- Two piece cast aluminum construction
- Allows the tuner to remove the camshaft without removing the oil pan
- Blanchard ground surfaces insures leak-proof operation
- Finned front cover for extra strength and appearance
- Cover comes complete with new seal & attaching hardware

		PART No.
CHEVY	153, 181, 194, 230, 250 & 292 cu. in. Aluminum Casting	82-1000
FORD	240, 300 cu. in.	PENDING
AMC	199, 232 & 258 cu. in.	PENDING
MOPAR	170, 198 & 225 cu. in.	PENDING

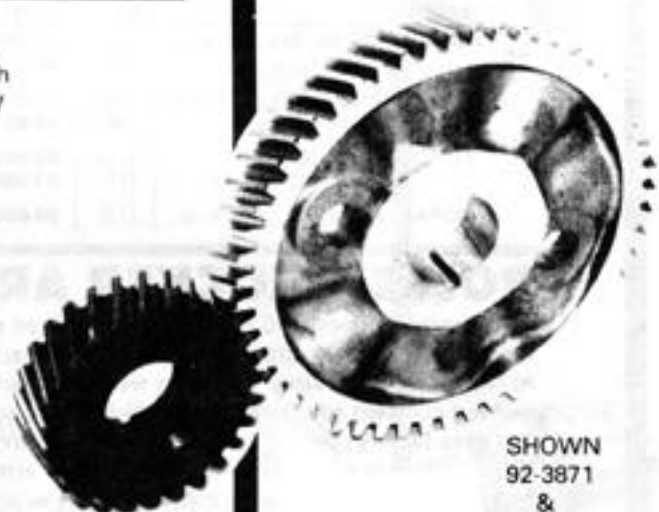

SHOWN  
92-3871  
&  
93-3871

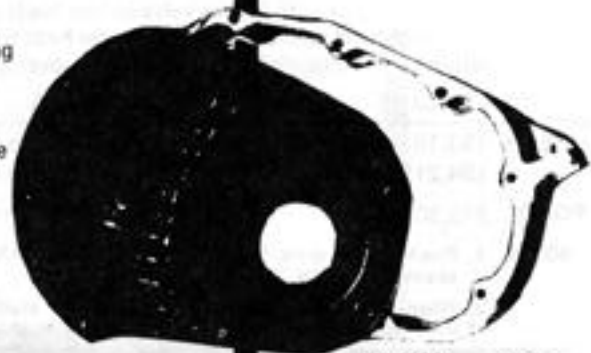

82-1000

## VARIABLE HYDRAULIC LIFTERS *IN A CLASS BY THEMSELVES*

- Only Rhoads lifters boost low-end torque up to 25% more over stock lifters.
- Rhoads lifters have the patented "ACCUGROOVE" which actually varies the valve timing automatically for incredible performance gains in LOW-END torque and engine vacuum with maximized fuel economy.
- Rhoads lifters can be used with ALL HYDRAULIC CAMS from mild to wild. The solid lifter sound means they're working!
- The lifter and cam life when using Rhoads lifters lasts longer than most OEM cams and lifters.

**NOTE:** When using Rhoads lifters most cam grinds will be approx. 20° less than rated. (i.e. a 280° cam will act like a 260° grind until 2500 rpm, therefore more low-end torque). These lifters are a **MUST** for automatic transmissions.

ENGINE	QTY.	PART NO.	SHP. WT.
AMC/JEEP 199, 232, 242, 258 (6 cyl.)	(12)	97-8901	5 lbs.
150 cu.in. (4 cyl.)	(8)	97-8911	4 lbs.
CHEVY 194, 230, 250, 292 (6 cyl.)	(12)	92-8901	5 lbs.
153, 181 (4 cyl.)	(8)	92-8911	4 lbs.
FORD 240, 300 (6 cyl.)	(12)	93-8902	5 lbs.
170, 200, 250 (6 cyl.)	(12)	93-8901	5 lbs.
MOPAR 225 (6 cyl. 1981 & up)	(12)	95-8901	5 lbs.

## ROLLER ROCKER ARMS

Made from the finest 356 Heat Treated anodized aluminum alloy, these rocker arms feature extra wide tips that mates perfectly with valve stem to reduce excessive valve and guide wear; maintains perfect valve-lash without constant adjusting. These rocker arms also have positive oiling and deep seating pushrod inserts. The trunions are precision ground and fitted with large needle bearings. These rocker arms only use 7/16" dia. rocker studs. All rocker arms come complete w/poly locks.

*NOTE: will not work with stock 3/8" dia. studs.*

ENGINE	RATIO	STUD DIA.	PART NO.
CHEVY 153, 181 (4 cyl.)	1.75	7/16" (set of 8)	92-3004
194, 215, 230, 250, 292 (6 cyl.)	1.75	7/16" (set of 12)	92-3002
FORD 240, 300 (6 cyl.)	1.60	7/16" (set of 12)	93-4002
AMC/JEEP 1972-up 232, 242, 258 6 cyl. engs. w/stamped steel rocker arms.	1.60	stock (set of 12)	97-5002
1984-up 150 (4 cyl.)	1.60	stock (set of 8)	97-5004

**NOTE:** These all NEW AMC/JEEP Roller Rocker Arms require no machining, just remove and replace. Stock push rods O.K.

## ROCKER ARM STUDS

Hi-Strength screw-in rocker studs replace stock pressed-in studs which are prone to pull out with higher valve spring loads and RPM. These studs are made from chromoly steel and are heat treated. These studs also feature rolled threads for better strength over cut threads.

ENGINE	STUD DIA.	PART NO.
CHEVY 153, 181 (4 cyl.)	7/16" (set of 8)	92-1250
194, 215, 230, 250, 292 (6 cyl.)	7/16" (set of 12)	92-1252
FORD 240, 300 (6 cyl.)	7/16" (set of 12)	92-1252

- NOTES:**
1. Stock rocker arms (using 3/8" dia. studs) CANNOT be used with above 7/16" dia. studs.
  2. When using the 7/16" dia. studs, CHEVY stud bosses need to be shortened approx. .400" and FORD bosses shortened approx. .100.

## Rhoads Lifters



**TECH INFO:**

Head studs give 20% more holding torque over cap screws, because they pull from the top down. All our grade 8 studs are made from 4130 chromoly steel and have rolled threads for maximum strength. All stud kits include; studs, nuts & washers.

**NOTE:** Valve covers usually need trimming for studs and sometimes require 2 gaskets to clear stud. Studs are a **MUST** for racing.

HEAD STUD KITS	1/2" DIA.
	Part No.
Chevy 194-292 (set of 14)	22-3040
Chevy 194-292 (set of 11)	22-3104
Ford 240-300 (set of 14)	22-3040
<b>NUTS &amp; WASHERS</b>	
Nuts (pkg. 10)	28-3472
Washers (pkg. 10)	28-3536

**SHIPPING WTS.**

Head stud kits-3 lbs. Nuts & Washers-1 lb.

## Hi-Performance Aluminum & Steel Rods

### Superrod

**FORGED  
ALUMINUM  
SUPER RODS**



Are made from the finest 2014 Aircraft Alcoa Aluminum alloy available and are heat treated for maximum strength. Special grade 9 rod bolts are also used. All rods come in stock lengths minus .010 inches to allow for stretch when hot. All rods come pin fitted to std. pin dia. size.

**ONLY SUPER RODS** can reduce 1/4 mile E.T.'s as much as .2 of a sec. in most large 6 cylinder Inline Engines. Reason for lower E.T.'s is that aluminum rods absorb engine shock vibrations which reduces H.P. during acceleration runs. These Rods are a **MUST** for all Drag, Oval Track, Sprint Cars and Midgets (blown or un-blown).

**SUPER  
TREATED  
STEEL RODS**



Are approx. 25% stronger than non-treated rods. The Super Treatment includes Mag. inspection, polishing, shot peening, bronze bushings for full pin float, H.D. Rod bolts and nuts. All rods are re-sized and cut for correct length and are pin fitted to Std. pin sizes.

These rods are best for Oval Track and Super Street usage.

**ADD FOR BALANCING**

Balancing is available at extra charge of \$21.00 for a set of 6 rods.

**ADD FOR USED CORE CHARGE**

of \$10.00 ea. less \$10.00 for clean & mag. when cores are returned.

DESCRIPTION		
<b>FORGED ALUMINUM SUPER RODS</b>		
GM 194,230,250; Pont.OHC 230,250	22-0160	10 lbs.
GM 292	22-0224	10 lbs.
FORD 240 w/.912 Pin	23-0144	10 lbs.
FORD 240 w/.975 Pin	23-0208	10 lbs.
FORD 300 w/.912 Pin	23-0272	10 lbs.
FORD 300 w/.975 Pin	23-0336	10 lbs.
AMC-RAMBLER 199(The 199 rod makes best length rod for all AMC engines. Special Pistons are required for all 232 & 258 engines.(see pg.40)	27-0144	10 lbs.
<b>SUPER TREATED STOCK STEEL RODS</b>		
GM 194,230,250	22-0288	12 lbs.
GM 292	22-0352	12 lbs.
FORD 262 w/.912 Pin	23-0400	12 lbs.
FORD 240 w/.912 Pin	23-0464	12 lbs.
FORD 240 w/.975 Pin	23-0528	12 lbs.
FORD 300 w/.912 Pin	23-0592	12 lbs.
FORD 300 w/.975 Pin	23-0656	12 lbs.
MOPAR 170	25-0112	12 lbs.
MOPAR 198,225	25-0176	12 lbs.
AMC-RAMBLER 199	27-0208	12 lbs.
AMC-RAMBLER 232	27-0272	12 lbs.
AMC-RAMBLER 258	27-0336	12 lbs.
<b>H.D. ROD BOLTS &amp; NUTS (Grade 8) (set of 12)</b>		
GM 194,230,250 (11/32" dia.)	22-3168	1 lbs.
GM 292 (3/8" dia.)	22-3232	1 lbs.
FORD 240-300 (3/8" dia.)	23-3600	1 lbs.

## GASKETS

**HEADGASKETS**

H.D. double laminated steel-asbestos type. (can be used for "O" ringed blocks). Compressed thickness is .032 (new) -.035 of an inch. This is best all-around gasket for compression ratios up to 11 to 1 even without "O" ringed blocks. (new)

**OVERHAUL SETS**

This "complete" gasket set contains: Stock intake & exhaust, valve cover, push rod cover, timing cover & oil seal, oil pan, fuel pump, water pump, valve seals, rear main seal, thermostat and H.D. double laminated steel-asbestos head gasket.

DESCRIPTION	HEAD GASKET	OVERHAUL SET
	PART NO.	PART NO.
AMC/JEEP 199-258 ALL	67-1040	67-1168
Chevy 235 (1954-62)	62-1056	62-1184
Chevy 261 (ALL)	62-1248	62-1376
Chevy 194,230,250 & 292	62-1140	62-1632
Ford 144-250-ALL	63-1424	63-1552
Ford 240-300 (ALL)	63-1616	63-1808
Mopar 170-225-ALL	65-1008	65-1136

**Shipping Wts.:**

Headgaskets 3 lbs.

Overhaul sets 6 lbs.





# HARMONIC DAMPERS

6=8

Clifford Performance now offers the Genuine Fisher harmonic damper. One of the most significant problems associated with inline engines is the severe twisting motion of the crankshaft (which is longer than a V-8 crankshaft). This torsional twisting of the crank can cause a myriad of problems, i.e., flywheel bolts loosening, crank bolts backing out, timing gear wear, valve spring breakage and even main bearing wear.

A good damper will bring harmony to any inline engine. The Genuine Fisher design is patterned after the style used on such inline engine pioneers as Packard, Mercedes and BMW. This design is virtually indelible, unlike the mass produced rubber OEM dampers that are single frequencies and often fail under even the slightest high performance usage. The Genuine Fisher damper incorporates a lightweight aircraft aluminum housing for fast revving and places the bulk of the weight in the inertia ring where it belongs. After installing the Genuine Fisher damper, you will see a big difference.



EXPANDED VIEW SHOWN

ENGINE	MAX O.D.	TOT. WT.	PART NO.
AMC/JEEP 2.5, 3.8 & 4.2 4 & 6 cyl. V-belt	7"	6 3/4 lb.	87-7166 VB
AMC/JEEP 2.5, 3.8 & 4.2 serpentine	7"	6 3/4 lb.	87-7166 S
AMC/JEEP 4.0 6 cyl. only V-belt	7"	6 3/4 lb.	87-7140 VB
AMC/JEEP 4.0 6 cyl. only serpentine	7"	6 3/4 lb.	87-7140 S
AMC/JEEP 2.5, 3.8 & 4.2 MOUNTING HUB ..... 87-7000			
AMC 4.0 ..... 87-7400			
MOPAR 6 cyl. (except flat heads)	7 1/8"	9 1/2 lb.	85-7657
EXTRA MOUNTING HUB ..... 85-7000			

ENGINE	MAX O.D.	TOT. WT.	PART NO.
CHEVY/GMC	6-3/4"	6-3/4 lb.	82-7356
All 4 & 6 cyl.	7-1/8"	9-1/2 lb.	82-7357
	7-1/2"	10-1/4 lb.	82-7358
EXTRA MOUNTING HUB ..... 82-7000			
FORD	6-3/4"	6-3/4 lb.	83-7256
240, 300	7-1/8"	9-1/2 lb.	83-7257
6 cyl.	7-1/2"	10-1/4 lb.	83-7258
EXTRA MOUNTING HUB ..... 83-7000			

**NOTE:** All Genuine Fisher Dampers will accept a front mounted 3 bolt GM style "V" pulley. Some engine accessory pulleys may have to be spaced to achieve proper belt alignment; except AMC/JEEP.

# JACOBS COMPUTER IGNITION

**A PACE-MAKER FOR THE HEART OF YOUR CAR!**

The original engineering principles of this Ignition System were derived by Dr. Christopher Jacobs while designing systems for heart pace-makers (for which he also holds several patents).



- Street legal for all 50 states
- Patented adaptive spark automatically adjusts to your engine's needs by varying the voltage, current and spark duration.
- 100% shock, water and vibration proof.
- Increases gas mileage and performance.
- Puts out up to 60,000 volts upon demand.

**TECH NOTE:** The JACOBS ignition computer operates by determining each cylinder's spark requirements by sensing spark plug electrical gap resistance. Hence, each spark plug is an exact Sensor for its own cylinder.

**WHERE OTHER IGNITIONS STOP- THE JACOBS STARTS!**

SEE PAGE 5 OF PRICE SHEET FOR THE FOLLOWING **NEW JACOBS PRODUCTS**

- OMNI-PACK COMPUTER IGNITION
- OPTO TIMER
- SPARK PLUG INDEXING WASHERS AND OTHER PRODUCTS

ITEM	DESCRIPTION & TECH INFO	P/N	WT.
COMPUTER TESTED COIL	12 volt Hi-Energy coil designed to work best with all Compusensor models. Most coils that are over 5 years old or 100,000 miles should be replaced. Fits all but GM HEI w/internal coil.	38-0672	3 lbs.
UNIVERSAL WIRE SETS (best choice for custom show car look)	This 7mm Hi-Energy core wire set is made for ALL 4 cyl. NON-GM HEI distributors with uni-clips & variangle boots. Fits female terminal distributor cap design only.	38-0704	2 lbs.
	This 7mm Hi-Energy core wire set is made for ALL 6 cyl. NON-GM HEI distributors with uni-clips & variangle boots. Fits female terminal distributor cap design only.	38-0706	2 lbs.
	This 8mm Hi-Energy core wire set is made for ALL 4 cyl. GM HEI & AMC/FORD DURA-SPARK distributors with uni-clips & variangle boots. Fits male terminal distributor cap design only.	38-0804	2 lbs.
	This 8mm Hi-Energy core wire set is made for ALL 6 cyl. GM HEI & AMC/FORD DURA-SPARK distributors with uni-clips & variangle boots. Fits male terminal distributor cap design only.	38-0806	2 lbs.

**TECH NOTE:**

All Mallory Dual Point Distributors come in 2 types. One with Vacuum Advance and the other without. Both types are fully mechanical advance operated. All Mallory distributors come complete with cap & rotor and will work with any coil and CompuSensor Computer. The advance curves can be easily altered to fit most engine requirements.

MALLORY DISTRIBUTORS			DUAL POINT		UNILITE		SH. WT.
			NO VAC.	W/VAC.	NO VAC.	W/VAC.	
CAR MODEL	YEAR	ENGINE SIZE	PART NO.	PART NO.	PART NO.	PART NO.	
AMC-JEEP, RAMB.	1965-up	199,232,258	33-6010	37-6010	35-6010	36-6010	12 lbs.
CHEVY	1937-62	216,235,261	33-1800	---	---	---	12 lbs.
CHEVY/PONT' OHV	1963-76	194,230,250,292	33-6280	37-6280	35-6280	36-6280	12 lbs.
CHEVY	1962-71	153 (4cyl.)	33-6820	37-6820	35-6820	36-6820	12 lbs.
GMC	1950-60	248,270,302	33-1800	---	---	---	12 lbs.
FORD	1965-up	240,300	33-6310	37-6310	35-6310	36-6310	12 lbs.
FALCON	1964-up	144,170,200,250	33-6300	37-6300	35-6300	36-6300	12 lbs.
PINTO-CAPRI	} 1971-up	2000cc	33-5820	37-5820	35-5820	36-5820	12 lbs.
PINTO-CAPRI		2300cc	33-5210	37-5210	35-5210	36-5210	12 lbs.
MUSTANG II		2600,2800cc	33-6080	37-6080	35-6080	36-6080	9 lbs.
CAPRI-MUST II	1973-up						
MOPAR	1960-up	170,198,225	33-6220	---	35-6220	---	12 lbs.
PONTIAC (4 cyl.)	1979-up	151 crossflow	33-6860	---	35-6860	---	12 lbs.
TOYOTA (6 cyl.)	1960-up	237,236,258	33-6410	37-6410	35-6410	36-6410	9 lbs.

## IGNITION PARTS and ACC.

DESCRIPTION	PART NO.	SH. WT.
COIL-12 Volt HI-PERF. PROMASTER SERIES Use with all Unilite and Electronic distributors plus all single & dual point distributors.	32-9440	3 lbs.
CONDENSER, Heavy Duty for all 33,34,37 dual point distributors.	30-0400	6 oz.
DISTRIBUTOR CAP, 4 cyl. Dual Point or Unilite distributors.	38-0271	1 lbs.
DISTRIBUTOR CAP, 6 cyl. Dual Point or Unilite distributors. Unilite distributors	38-0270	1 lbs.
MODULE ASSY, Unilite Distributor, fits all models 4 or 6 cyl.	30-0605	1 lbs.
POINT ASSY, one piece H.D. set for all 33,34,37 model distributors.	32-5042	1 lbs.
POINT & ASSY KIT, Kit contains 2 H.D. points & condenser.	33-9320	1 lbs.
ROTOR 23, 33,34,37 series Distributor, Fits all 4 & 6 cyl. distributors.	33-0309	1 lbs.
ROTOR/SHUTTER ASSY: Fits all 4 cyl. Unilite 45 series distributors w/no vac.	30-0340	1 lbs.
Fits all 4 cyl. Unilite 47 series distributors w/vac.	30-0325	1 lbs.
Fits all 6 cyl. Unilite 45 series distributors w/no vac.	30-0339	1 lbs.
Fits all 6 cyl. Unilite 47 series distributors w/vac.	30-0323	1 lbs.

- Mallory Dual Point Mechanical and Vacuum Advance Distributor Features**
- The brass case condenser minimizes corrosion. Mylar insulation prevents shorts and leakage.
  - Self-lubricating bushings provide wear-free, trouble-free service.
  - Super Duty Cap and Rotor designed with space age materials prevent chipping and flaking. Brass terminals assure maximum conductivity.
  - Unique design allows for the maximum advance curve.
  - Dual Stabilized Contact Points with wear resistant and bounce to increase conductivity.
- Performance Benefits of the UNILITE® Electronic Distributor**
- Improved combustion with increased efficiency.
  - Increased spark plug life.
  - Improved cold weather starting.
  - Increased RPM potential.
  - Maintenance free operation.
  - Accurate spark timing.



PROMASTER COIL



CAPS & ROTORS



HD POINTS



HD COND.



STOCK DIST. ADVANCE CURVE KITS	DESCRIPTION	PART NO.	SH. WT.
Custom tailor your own stock dist. curve with these in-expensive kits. These kits allow full advance between 2000 & 2500 RPM. A must for Hi-Perf. engines.	GM-AMC Delco (56-68)	32-8000	8 oz.
	GM-AMC Delco (69-74)	32-8064	8 oz.
	AMC/FORD Motorcraft	33-8048	6 oz.
	Mopar (1959 & later)	35-8016	6 oz.
	GM-HEI series (1975-84)	32-8070	8 oz.

Not legal for sale or use in California on any pollution controlled motor vehicles. These products are intended for racing purposes only. See back cover for other limitations.

**6=8**

# DOMESTIC cast & forged PISTONS

**PISTON SIZES:** Pistons are available in Std., .030, .040 & .060 (.062) overbore sizes at no extra charge.**NOTE:** All pistons come pin-fitted with medium duty wrist pins. Heavy Duty 4340 chromoly pins available with aluminum buttons on request. (SEE NOTE 6 UNDER EXTRA CHARGES).**HOW TO ORDER:** 1. State Part No. and Bore size desired. 2. State compression Ratio desired. 3. State engine model, year and size. 4. State bore stroke, rod or crankshaft if other than standard. 5. 6 cyl. shipping wt. 15 lbs. & 4 cyl. 12 lbs. 6. State any other Extra Charge listed below.*NOTE: state cam lift & duration too!!***EXTRA CHARGES:****NET COST**

- Sizes other than those above ADD ..... \$2.00 ea.
- Pistons with other than stock stroke ADD ..... \$2.00 ea.
- Pistons with other than 5/64 x 3/16 ring width ADD ..\$2.00 ea.  
(Except cast pistons come ONLY in 5/64 x 3/16 width)

**EXTRA CHARGES:****NET COST**

- Piston Balancing for each piston balanced ADD..... \$ 4.00 ea.
- ADD 20% more over 6 cyl. price for broken lot sets. (Min. Order - 4)
- Heavy Duty 4340 chromoly pins and alum. button ADD \$15.00 ea.  
(Forged Pistons ONLY. State bore size and pin dia. when ordering)

DESCRIPTION	STD. BORE SIZES	COMP. DIST.	PIN DIA.	RING SIZE	CAST P/N	FORGED P/N
AMC/JEEP 199	3-3/4, 3-13/16	1-44/64	.9311	(2)5/64-K, (1)3/16-0	27-6122	27-6480
AMC/JEEP 232	3-3/4, 3-13/16	1-39/64	.9311	(2)5/64-K, (1)3-16-0	27-6123	27-6485
AMC/JEEP 258	3-3/4, 3-13/16	1-45/64	.9311	(2)5/64-K, (1)3-16-0	27-6132	27-6488
Chevy 235	3-9/16, 3-5/8	2-1/16	.865	(2)3/32-K, (1)3/16-0	22-6100	22-6305
Chevy 261	3-3/4, 3-7/8	2-3/16	.9275	(2)5/64-K, (1)3/16-0	22-6101	22-6310
Chevy 194	3-9/16, 3-5/8	1-51/64	.9275	(2)5/64-K, (1)3/16-0	22-6102	22-6325
Chevy 153 (4cyl.)	3-7/8, 3-15/16, 4.00	1-51/64	.9275	(2)5/64-K, (1)3/16-0	22-6103	22-6315
Chevy 181 (4 cyl. Marine)	4, 4-1/16	1-5/8	.9275	(2)5/64-K, (1)3/16-0	22-6141	22-6320
Chevy 230	3-7/8, 3-15/16, 4.00	1-51/64	.9275	(2)5/64-K, (1)3/16-0	22-6104	22-6330
Chevy 250	3-7/8, 3-15/16, 4.00	1-21/32	.9275	(2)5/64-K, (1)3/16-0	22-6105	22-6335
Chevy 292	3-7/8, 3-15/16, 4.00	2-1/32	.9275	(2)5/64-K, (1)3/16-0	22-6106	22-6345
Chevy 230-250 w/292 crank	3-7/8, 3-15/16, 4.00	1-23/64	.9275	(2)1/16-K, (1)1/8-0	---	22-6343
Chevy 230-250 (note 2)	3-7/8, 3-15/16, 4.00	1-25/64	.9275	(2)5/64-K, (1)3/16-0	---	22-6340
Chevy 292 w/4-3/8 stroke	3-7/8, 3-15/16, 4.00	1-29/32	.9275	(2)5/64-K, (1)3/16-0	---	22-6350
Ford 215, 223	3-9/16, 3-5/8, 3-3/4	1-7/8	.9123	(2)5/64-K, (1)3/16-0	23-6107	23-6355
Ford 262	3-23/32, 3-25/32, 3-7/8	1-57/64	.9123	(2)5/64-K, (1)3/16-0	23-6108	23-6360
Ford 144	3-1/2, 3-9/16	1-45/64	.9123	(2)5/64-K, (1)3/16-0	23-6109	23-6365
Ford 170	3-1/2, 3-9/16	1-39/64	.9123	(2)5/64-K, (1)3/16-0	23-6110	23-6370
Ford 200	3.680, 3-3/4	1-33/64	.9123	(2)5/64-K, (1)3/16-0	23-6111	23-6375
Ford 250	3.680, 3-3/4	variable	.9123	(2)5/64-K, (1)3/16-0	23-6139	23-6378
Ford 240	4.00, 4-1/16	1-39/64	.9123	(2)5/64-K, (1)3/16-0	23-6112	23-6380
	4.00, 4-1/16	1-39/64	.975	(2)5/64-K, (1)3/16-0	23-6113	23-6385
Ford 300	4.00, 4-1/16	1-49/64	.9123	(2)5/64-K, (1)3/16-0	23-6114	23-6400
	4.00, 4-1/16	1-49/64	.975	(2)5/64-K, (1)3/16-0	23-6115	23-6405
Ford 240-300 w/300 crank & 240 rods	4.00, 4-1/16	1-11/64	.9123	(2)1/16-K, (1)1/8-0	---	23-6390
	4.00, 4-1/16	1-11/64	.975	(2)1/16-K, (1)1/8-0	---	23-6395
Ford 300 w/4-3/8 stroke crank & 300 rods	4.00, 4-1/16	1-31/64	.9123	(2)5/64-K, (1)3-16-0	23-6142	23-6410
	4.00, 4-1/16	1-31/64	.975	(2)5/64-K, (1)3-16-0	23-6143	23-6415
GMC 248, 270, 302 (note 1)	3-7/8, 4.00, 4-1/16, 4-1/8	2-23/64	.990	(2)5/64-K, (1)3-16-0	22-6116	22-6420
GMC 302 w/248 crank	4.00, 4-1/16, 4-1/8	2	.990	(2)5/64-K, (1)3-16-0	---	22-6425
Mopar 170	3.400, 3-1/2, 3-9/16	1-49/64	.9008	(2)5/64-K, (1)3-16-0	25-6118	25-6445
Mopar 196, 225	3.400, 3-1/2, 3-9/16	variable	.9008	(2)5/64-K, (1)3-16-0	25-6119	25-6450
Pont.OHC 230	3-7/8, 3-15/16	1-51/64	.9275	(2)5/64-K, (1)3-16-0	26-6120	26-6465
Pont.OHC 250	3-7/8, 3-15/16	1-21/32	.9275	(2)5/64-K, (1)3-16-0	26-6121	26-6470
Pont.OHC 230-250 w/Chevy 292 crank	3-7/8, 3-15/16	1-25/64	.9275	(2)5/64-K, (1)3-16-0	---	26-6475

**NOTES:** 1. Forged piston has 2-15/64 comp. dist. with 1/8 block milling req'd. 2. Chevy 230-250, w/292 de-stroke crank (4-1/16).

• Other DOMESTIC &amp; FOREIGN pistons are available upon request.

**6=8**

# PISTON RINGS

**RING SIZES:**

All rings are available in Std. &amp; .010, .020, .030, .040, .050, &amp; .060 oversize above sizes listed in table.

**HOW TO ORDER:**

List part no. and any oversize above Std. listed in table.

Domestic large and small displacement engines can use a wide variety of rings like iron moly or chrome plated compression rings which do the job best and most economically for Street or Strip applications. Perfect Circle and American Hammered rings are tops in this field with 90% of most cars using these rings as standard equipment.

Domestic large and small racing engines that demand the strongest ring should use a ductile steel moly or chrome plated compression rings. Perfect Circle and American Hammered rings are the choice of Winners for Extra Super Duty rings.



Shipping wt. 3 lbs.

DESCRIPTION	Ring Sizes Available	RING WIDTH	PART NO.	
			4 cyl.	6 cyl.
Chrome or Moly top ring, iron 2nd. ring & chrome oil 3 rd. ring	3.00 dia. thru 4.1875 dia.	(2) 3/32 K, (1) 3/16-0 (2) 5/64 K, (1) 3/16-0	20-6292	20-6207 20-6222





**TECH INFO:**

All Clifford flywheels, STEEL or ALUMINUM are custom made specifically for 4 & 6 cyl. cars. Only the finest steel billet material is machined into a super strong flywheel. All flywheel bolt holes are made with close-tolerance to help reduce vibration problems which plague most 6 cyl. cars. A 6 cyl. car and standard weighted steel flywheel has sufficient launch power for most Drag cars. The reason is simple, a 6 cyl. engine produces 30% more torque over equal size V-8 engines, so extra weight flywheels are not needed for most 6 cyl. cars.

ALUMINUM flywheels all have steel or bronze heat faces which are riveted to the Aluminum. These faces can be re-surfaced as required to insure maximum holding power and longest life.

**HOW TO CHOOSE A FLYWHEEL:**

1. **STREET & STRIP CARS:** always use STEEL, not Aluminum flywheels.
2. **DRAG CARS:** use Steel or Aluminum. NOTE: Aluminum is only used with large displacement engines.
3. **OVAL TRACK CARS:** use the lightest flywheel and clutch pressure assemblies possible. Aluminum flywheels and clutches are a MUST!



Racing Fly Wheel - Aluminum With Sintered Bronze Heat Shield

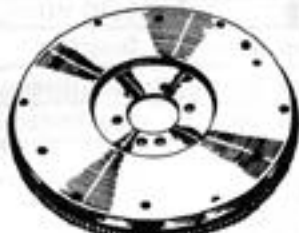

Typical "Steel" Racing Flywheel

YEAR	ENGINE SIZE	RING GEAR TEETH	CRANK BOLT SIZE	STANDARD CLUTCH PATTERN	STEEL (Standard Wt.)		ALUMINUM	
					PART NO.	SH. WT.	PART NO.	SH. WT.
AMC, GREMLIN, HORNET, JAVELIN & PACER				NOTE: (1) Driver's side starter.				
1965-71	199,232,258	153	1/2	9%,10% B & B	87-0016	35 lbs.	87-1040	15 lbs.
1972-up	232,258	164	1/2	10%,10%-11 B & B	87-0080	38 lbs.	87-1104	17 lbs.
CHEVROLET & GM 4 & 6 CYL. CARS								
1954-62	235,261	168	7/16	10%,10%-11 B & B	82-0032	35 lbs.	82-1056	19 lbs.
1960-78	153,194,230,250,292	153	7/16	10% B & B	82-0096	31 lbs.	82-1120	15 lbs.
1962-up	194,230,250,292	168	7/16	10%,10%-11 B & B	82-0160	36 lbs.	82-1184	17 lbs.
1970-up	292	168	1/2	10%,10%-11 B & B	82-0224	36 lbs.	82-1248	17 lbs.
1970-up	292	153	1/2	10% B & B	82-0288	31 lbs.	82-1312	16 lbs.
FORD, FALCON, MAVERICK, MUSTANG & COMET								
1953-64	223,262	146	7/16	10,10% & 11 Long 10% B & B	83-0016	39 lbs.	83-1040	18 lbs.
1965-up	240,300	164	7/16	10,10% & 11 Long 10% B & B	83-0080	39 lbs.	83-1104	18 lbs.
1960-up	144,170,200	132	7/16	8% B & B(recessed)	83-0144	25 lbs.	---	---
1965-up	170,200	136	7/16	8% B & B(recessed)	83-0208	28 lbs.	---	---
1965-up	170,200	136	7/16	9-1/8 Long	83-0272	28 lbs.	83-1168	15 lbs.
1969-up	250	157	7/16	10,10% Long	83-0336	36 lbs.	83-1232	17 lbs.
GMC 248,270 & 302								
1952-59	248	168	4 bolt	10%,10%-11 B & B	82-0480	34 lbs.	82-1504	18 lbs.
1952-59	248,270,302	168	1/2	10%,10%-11 B & B	82-0544	34 lbs.	82-1568	18 lbs.
MOPAR SLANT 6 NOTE: 1962-67-Hub center hole must be enlarged.								
1960-61	170,225	148	7/16	9% B & B	85-0048	26 lbs.	85-1008	15 lbs.
1962-up	170,198,225	122	7/16	9% B & B	85-0112	26 lbs.	85-1072	15 lbs.

# BELLHOUSINGS

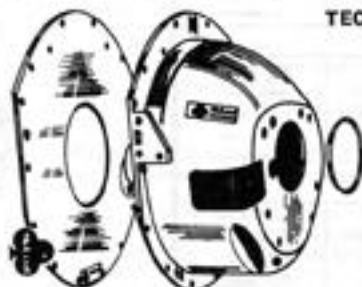

**TECH INFO:**

The reason for a safety bellhousing and block plate is to contain the fragments of the explosion of a flywheel and/or clutch assembly. Most stock auto bellhousings are made of cast iron or aluminum which CANNOT contain a flywheel and/or clutch assembly explosion. As a result most National Sanctioning Organizations require the use a 360° safety bellhousing or shield. All the bellhousings listed below are made from 1/4" thick steel plate. These bellhousings meet or exceed the SEMA specs. and are accepted by all Racing Associations.

NOTE: All Bellhousings come standard with Block Plates & Bolts

ENGINE MODEL	YEAR	CLUTCH SIZE	PART NO.	SH. WT.
GM 153,194,230,250,292	1962-up	10-1/2,11	82-7008	49 lbs.
GM,BUICK V-6 90 degree	1955-up	10-1/2,11	82-7072	49 lbs.
FORD 240,250,300	1965-up	10,10-1/2,11	83-7056	46 lbs.



# CLUTCH DISCS



### HOW TO CHOOSE A CLUTCH DISC:

1. **Street & Strip Cars:** always use sprung hub with conventional 3 or 4 speed transmissions.
2. **Drag or Oval Track Cars:** use the solid hub for maximum service.

**SHIPPING INFO:** Average shipping weight of clutch disc is 8 lbs.

YEAR	ENGINE SIZE	HUB DIA. & SPLINE	TRUE DISC DIA.	SPRUNG HUB		SOLID HUB
				Street/Strip	Road Race	Drag/Oval
				Riveted	Bonded/Riveted	Bonded/Riveted
				PART NO.	PART NO.	PART NO.
<b>AMC/JEEP, GREMLIN, HORNET, JAVELIN &amp; PACER</b>						
1965-72	199,232,258	15/16 x 10	9-1/4	87-4048	---	---
		15/16 x 10	10.4	87-4112	87-5072	87-6096
1973-up	232,258	1-1/8 x 10	10.4	87-4176	87-5136	87-6160
		1-1/8 x 10	11	87-4240	87-5200	87-6224
<b>GM CARS &amp; TRUCKS - ALL</b>						
1954-up	153,194,215,230,235	1-1/8x10	10.4	82-4000	82-5024	82-6048
	248,250,270,292,302	1-1/8x10	10.95	82-4064	82-5088	82-6112
<b>FORD CARS &amp; TRUCKS - ALL</b>						
1953 thru 1989	223,240 250 262,300	1-1/16x10	10	83-4048	---	---
		1-1/16x10	10.4	83-4112	83-5072	83-6032
		1-1/16x10	11	83-4176	83-5136	83-6096
		1-3/8x10	11	83-4240	83-5200	83-6160
1960-65	144,170,200	15/16x10	8-1/2	83-4304	83-5264	---
1965-up	170,200	1-1/16x10	8-1/2	83-4368	83-5328	83-6224
1965-up	170,200	1-1/16x10	9-1/8	83-4432	83-5392	83-6288
<b>MOPAR SLANT 6</b>						
1960 thru 1978	170,198,225	1x23	9-1/8	85-4016	85-5040	85-6064
		1x23	10.4	85-4080	85-5104	85-6128

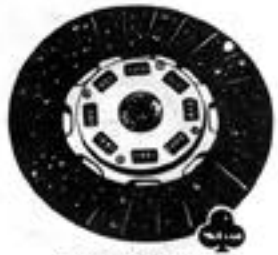

SPRUNG HUB

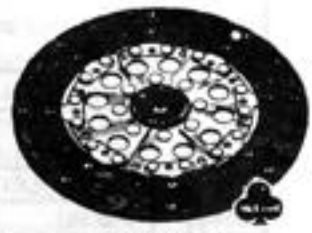

SOLID HUB

# PRESS. PLATES

### HOW TO SELECT THE RIGHT PRESSURE PLATE ASSY.

1. **Street & Strip Cars:** If extra holding power and High RPM is not critical, use Borg & Beck with rollers, diaphragm or counter weighted (CW) Long series pressure plate assembly.
2. **Drag Cars:** If very high RPM shifting is required, use Borg & Beck units without rollers, diaphragm or Long units without (CW's) counter weights.
3. **Oval Track Cars:** If no gears are shifted, use extra pressure units like Borg & Beck with rollers or Long units with (CW's) counter weights.



Typical "Long" (Ford Style) Pressure Plate



Typical "Long/Borg & Beck" Pressure Plate



Typical "Diaphragm" Style Pressure Plate

YEAR	ENGINE SIZE	SIZE & TYPE	STEEL ASSY.	ALUM. ASSY.
			Street Strip PART NO.	Oval / Road Race PART NO.
<b>AMC - GREMLIN, HORNET &amp; JAVELIN, PACER</b>				
1965-71	199,232,258	9-1/4 B & B	87-2000	---
		10-1/2 B & B	87-2064	87-3024
1972 thru 1989	232,258	10-1/2 B & B	87-2128	---
		10-1/2, 11 B & B	87-2192	87-3024
		10-1/2, 11 B & B	87-2256	---
<b>CHEVROLET &amp; GM CARS (Buick, Olds &amp; Pont.)</b>				
1952 thru 1989	153,194 215,235,230 250,261,292 248,270,302	10-1/2 B & B	82-2016	82-3040
		10-1/2 B & B	82-2080	---
		10-1/2 Diaphragm	82-2144	---
		11 B & B	82-2208	---
		11 B & B	82-2272	---
<b>FORD CARS</b>				
1953 thru 1989	223,262 250 240,300	10-1/2 Long	83-2064	---
		10-1/2 Long	83-2128	---
		11 Long	83-2192	83-3088
1960-76	144,170,200	8-1/2 B&B	83-2256	---
1969-up	250	10-1/2 Long	83-2128	---
<b>MOPAR SLANT SIX</b>				
1969-up	170,198,225	9-1/8 Diaphragm	85-2032	---
		9-1/4 B & B	85-2096	---



**SHIPPING INFO:** Average steel pressure assy. is 22 lbs.

Average aluminum press. assy. is 16 lbs.



# Superchargers



Superchargers are a great way to improve both the looks and power output of any inline 6 cyl. engine. Inline Superchargers have been popular over the years. Kits were made in the late '40s. The mid '50s saw more inline blower kits in the marketplace. Now Hunter Performance offers supercharger kits based upon the '90s blower technology using the latest B & M Automotive Superchargers and components.

Hunter Performance can help you with nearly any inline supercharger project. Kits based upon the B & M 112 cid. blower and now the B & M 144 cid. Power Charger II can be assembled. Hunter helps you to build it in cost-effective stages I, II, III with your membership in the American Supercharger Club. Both side-draft and down-draft Supercharger Kits are available. No need to cut hoods. Supercharger Tech. kits are available too. Order direct from Hunter Performance Inc. 9302 Livernois Houston, Tx. 77080 (713) 461-BLWN

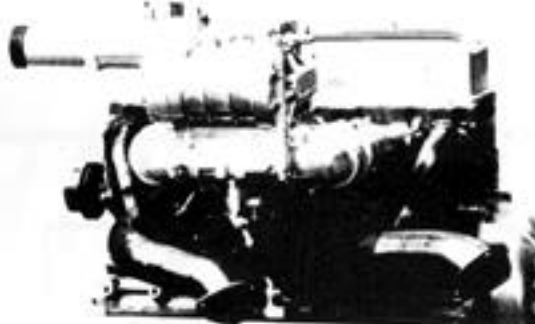

Hunter Performance Inc.  
9302 Livernois  
Houston, Tx. 77080  
(713) 461-BLWN

The American Supercharger Club  
9302 Livernois  
Houston, Tx. 77080  
(713) 461-BLWN

## HEADER COATING

**SERMATIZING** is a Space Age Metallic-Ceramic coating process when applied to a header, provides a life-time rust free finish. This extra ordinary coating has a high luster polished aluminum look finish that can be easily cleaned. (coated inside & out).

### BENEFITS:

- It will not turn blue or oxidize.
- Rust-Proof finish, a MUST for salted roads.
- Will not burn off. Can with stand temperatures of plus 1300° F to minus 375° F.
- Helps to reduce under hood temperatures.

HOW TO ORDER HEADER  
SERMATZE COATING

Add \$175.00 to the price of All 6 cyl. Headers.  
Add \$125.00 to the price of All 4 cyl. and street rod headers.

6=8

# ACCESSORIES

6=8

## CLIFFORD CAPS & T-SHIRTS

Popular cotton cap features white face and royal blue bill with "CLIFFORD" logo.  
NOTE: 5 position adjustable strap

Brightly screened with Red & Blue color art work, these short-sleeved T-shirts are made from 50% cotton and 50% polyester to reduce shrinking

Part No. 98-200 ALL BLUE COTTON  
Part No. 98-300 BLUE & WHITE COTTON

SIZES	PART No.	SIZES	PART No.
small	98-0010	large	98-0030
medium	98-0020	ex-large	98-0040



## CLIFFORD LOGO PATCH

The distinctive Clifford logo embroidered patch has a royal blue background and white letters with 6=8 in red. Size 2"x4".  
Ideal for all types of clothing. (New Style)

PART No. 98-0400



## CLIFFORD DECALS

2 sizes of Clifford decals are available. Both are made from quality fade-resistant Vinyl.

DESCRIPTION	PART No.
5 pak regular size 2 1/4" x 6 3/4"	98-0500
10 pak small size 1 1/4" x 3"	98-0520

